

SIMPLE.
CONSISTENT.
RELIABLE.

.....
Convenience that I trust.

“OUR RECIPE FOR SUCCESS IS BASED ON COOPERATION.”



Dirk Giersiepen

Managing Director of
Gira Giersiepen
GmbH & Co. KG

Two traditional family-owned companies
and the developers of eNet SMART HOME

Harald Jung

Managing Director
of Albrecht Jung
GmbH & Co. KG

“Quality, flexibility for the future, a user-friendly variety of solutions, data protection and servicing by qualified specialist tradesmen – these are all features you expect a smart solution in specialist retail to have if it is to win the confidence of end customers and tradesmen alike. In that respect, it was obvious for us, as a long-standing partner in specialist retail, to tackle these high requirements together.

Our goal was to develop a stable and secure wireless system that guarantees a high level of reliability on the one hand and can be operated with ease and from any location on the other. It should also be easy to install and thus suitable for many households. And the eNet SMART HOME ticks all these boxes.

To remain multifunctional, we rely on active partnerships with strong European brands in specialist retail. That way, we guarantee our customers outstanding quality, product diversity and a future-proof system standard – naturally across various brands from a single app.

Unlike many other smart home systems available on the market, we don’t abandon users with our solutions. Our conviction and tradition means we place our trust in the expertise of specialist tradesmen. With their know-how, they can turn interested individuals’ requests and requirements into a reality. They will receive professional advice on their smart home and have a local contact on hand even after installation who will adapt the system to new life situations as needed.

We firmly believe that

eNet SMART HOME is simple, consistent and reliable.
eNet SMART HOME is convenience that we trust.”

CONTENTS

Understanding eNet	10	OVERVIEW OF DEVICES	56
eNet SMART HOME	12	1. eNet wall transmitters and operating top units	56
Smart home means convenient living	12	2. eNet hand-held transmitters	58
eNet SYSTEM	14	3. Operating panels	59
Old hands at new technology	14	4. eNet devices in the Mini housing	60
An excellent cooperative relationship	16	5. eNet DIN rail-mounted devices (DRAs)	61
The eNet convenience system	18	6. eNet adapter plugs	63
eNet PRINCIPLES	20	7. Physical sensors	63
Five principles mean five reasons for installing	20	8. eNet heating system control	64
eNet SERVICE PARTNERS	22	9. Other eNet devices and designs	65
Setting up with advice from the specialists	22	SWITCHING, PRESSING AND DIMMING	66
eNet CONTROLLING	24	1. Switching and pressing	66
Control your home	24	2. Dimming	67
eNet SOLUTIONS	26	3. Buttons for switching/dimming inserts	68
Practical solutions	26	4. Light control hierarchies	69
A system for everyone	28	AUTOMATIC LIGHT	70
eNet QUALITY COMMITMENT	40	The function in detail	70
Quality that exceeds legal requirements	40	BLINDS, ROLLER SHUTTERS AND AWNINGS	78
eNet PARTNER BRANDS	42	1. Function	78
eNet links up powerful brands	42	2. Shading solution positions	79
eNet DESIGN EXPERTISE	44	3. Operating modes	80
Gira	44	4. Special functions	82
JUNG	46	5. Blind button	83
Overview of the eNet SYSTEM	48	6. Blind control hierarchies	84
eNet AND eNet SMART HOME	50	HEATING	86
1. eNet	50	Heating	86
2. eNet SMART HOME	52	WIRELESS TRANSMITTERS	90
3. Features of eNet and eNet SMART HOME	54	1. Hand-held transmitters and wall transmitters	90
4. Sensors and actuators	55	2. Status messages	91
		3. Universal transmitters	94

SCENES AND SPECIAL FUNCTIONS	96	SERVICE AND DIAGNOSTICS	138
1. Technical background	97	1. Service cases	138
2. Smart home scenes	98	2. Systematic troubleshooting	140
3. Manual scenes	100	3. Troubleshooting tools	144
4. "Everything on/up" – "Everything off/down"	101	4. Troubleshooting in systems with repeaters	147
5. More functions	102	5. Connection with eNet SMART HOME app	148
6. "Scenes for signal contacts" operating mode	103	6. Remote maintenance via eNet SMART HOME remote	149
eNet SERVER	104	SAMPLE APPLICATIONS	150
1. eNet SMART HOME connect commissioning interface	105	The perfect atmosphere for a cosy film night	152
2. Operation and automation using the eNet SMART HOME app	107	Comfortable temperature setting in all rooms	153
3. Assembly and network connection	112	via fixed operating panel	
4. Data security	113	Light dimmed at night in the bathroom and in the hallway	154
5. eNet SMART HOME secure	113	Controlling the home via a smartphone – at home or on the move	155
6. Encrypted remote access – eNet SMART HOME remote	114	Glass front with eNet wall transmitter	156
7. WLAN encryption	115	Bedroom lighting with eNet wall transmitter at the bedside	157
8. Recommendations for security	115	Time-controlled blind control using an eNet universal transmitter	158
DEVICES FOR INSTALLATION IN DISTRIBUTORS	118	Blind control in groups or centrally	159
1. Setup	118	Automatic light outdoors with eNet wall switch for	160
2. DRA receiver module	120	all-round lighting	
3. eNet server as the receiver module	120	Wall transmitter in the entrance area with scenes for	161
4. DRA application modules	120	"Central off" and "Welcome"	
SENSORS	122	Lighting scenes with eNet wall transmitters or your smartphone	162
1. Energy sensors	122	eNet actuators in the distribution box	163
2. Sun/twilight sensor Solar	122	Blind control with sun protection and twilight function	164
3. Conventional sensors with switching contact	123	plus lockout protection	
DIGITALE DIENSTE		Energy consumption display and load-dependent signalling	165
1. Voice Control via Amazon Alexa	124	Automatic stairwell lighting intelligently retrofitted	167
2. Voice Control via Google Assistant	127	ANNEX	168
PLANNING AND COMMISSIONING	128	Medium	170
1. Phase 1: Defining functions	128	Updating to eNet SMART HOME	183
2. Phase 2: Selecting devices	130	Compatibility with in other systems	184
3. Phase 3: Installing the system	131		
4. Manual commissioning	131		
5. Commissioning with the eNet server	133		

UNDERSTANDING eNet

SMART HOME MEANS CONVENIENT LIVING

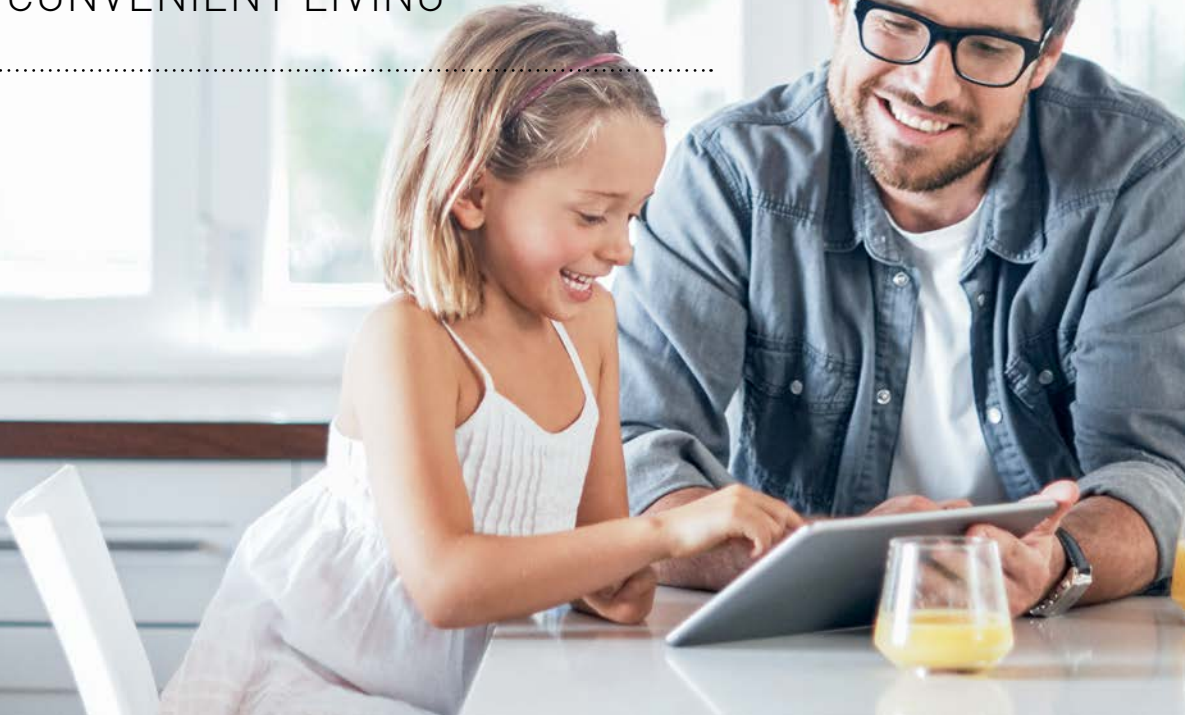

But how exactly does a smart home make your everyday life easier?
By controlling itself. How and when you want it to.
Therefore it takes some of your everyday tasks off your hands.
Your life is made more convenient – and you even make savings too.
Because electricity is only consumed when it is needed.
It's simply intelligent.

What does this increased convenience look like in specific terms?
Your devices can communicate with one other. While this might sound simple initially, it opens up possibilities you'd never have imagined.

How does this sound? You get up in the morning, your blinds raise automatically, the light in the kitch-

en switches on, and your coffee machine is ready and waiting to make you a delicious beverage. Your heater has pre-heated your bathroom to your desired temperature. You can save yourself the trouble of checking whether all the appliances are switched off before heading out. All you have to do is switch everything off with a tap of your fingertip. And it's only morning time ...

Now, all the benefits are in the palm of your hand. Because you can conveniently control your smart home from any location using your smartphone. Whether you're at home or not.

You can also control your smart home using a transmitter on the wall. And that is a real eye-catcher.

If you're thinking that installation is sure to be complicated, we can assure you that the advisory and installation processes are carried out by a specialist from your local region. You say what you want your home to be able to do. And the specialist will set up the system to suit your requests and requirements. If your requirements increase sometime in the future, the system will simply evolve with them. The specialist engineer will remain your personal contact even after the installation process is complete.

OLD HANDS AT NEW TECHNOLOGY

We aren't newcomers to the market. eNet has been networking lights and blinds via a bidirectional wireless system for years. Wireless communication has proven itself to be successful. The installation process is quick and mess-free. Walls and cables remain intact. And that's why upgrading the system is also very simple. eNet has offered and still does offer smart functions. Now, eNet SMART HOME is providing you with an entire system.

eNet IS FLEXIBLE

eNet. Sure, it sounds good. But it probably won't be suitable for your home, right? Wrong. Because, as we mentioned before, we use wireless communication. Whether it's a rental flat, an old building, a private home or a commercial building is by the by. eNet devices are out of sight in existing device boxes or sub-distributors. Your specialist engineer will install manual operating stations precisely where they're needed.

Where your cables are situated is of no importance. As a result, you get the latest technology without any annoying construction measures.

The choice is yours. Are you interested in individual functions? Then our classic eNet solution is ideal for you. You control both the lighting and blinds with hand-held and wall transmitters.

eNet IS BECOMING SMART

Do you already own an eNet system? Would you like to expand it to include more functions?

Then all you have to do is upgrade it to the eNet SMART HOME. We have achieved our goal, i. e. to create a robust system for you which adapts to your life. Just the way you want it to. For today. And tomorrow. And the days after tomorrow. Please contact your specialist engineer to find out more. The service is still the

same eNet service. A specialist will advise you and upgrade your smart home the way you want. Your home will become as smart as you want it to be.

Thanks to eNet SMART HOME secure, communication between your appliances is encrypted. After all, dependability is also all about data security.

eNet works. Consistently.



AN EXCELLENT COOPERATIVE RELATIONSHIP

Would you like to control your smart home in a very specific way? Very well. You can do that too. Because we let you choose. Either you use your smartphone while on the move or go for the classic option – using light switches, hand-held transmitters and wall transmitters. Control the way you want and what you want.

The eNet server is the key component of the system. It is the hub through which the operating units and the devices to be controlled communicate. Commissioning takes place through the server working with a PC. And then you're ready to go.

The app enables control while on the move. Then communication is via the internet. And when you are at home, your smartphone or tablet communicates with the server via your network.

The server forwards your commands to actuators. Which turn your requests into functions. That's how simple it is.

Physical sensors complete the system. Energy sensors control your

appliances' consumption values. Sun sensors enable automatic control of blinds. Which means that your shading system can adapt to sunlight and temperature.

tado°'s smart heating system control integrates perfectly in the eNet SMART HOME system.

You, too, can profit from our eNet SMART HOME applications in Amazon Alexa and Google Assistant.

Combine our functions and solutions in a way which is comfortable for you.

Would you like more ideas? Then visit us at

www.enet-smarthome.com

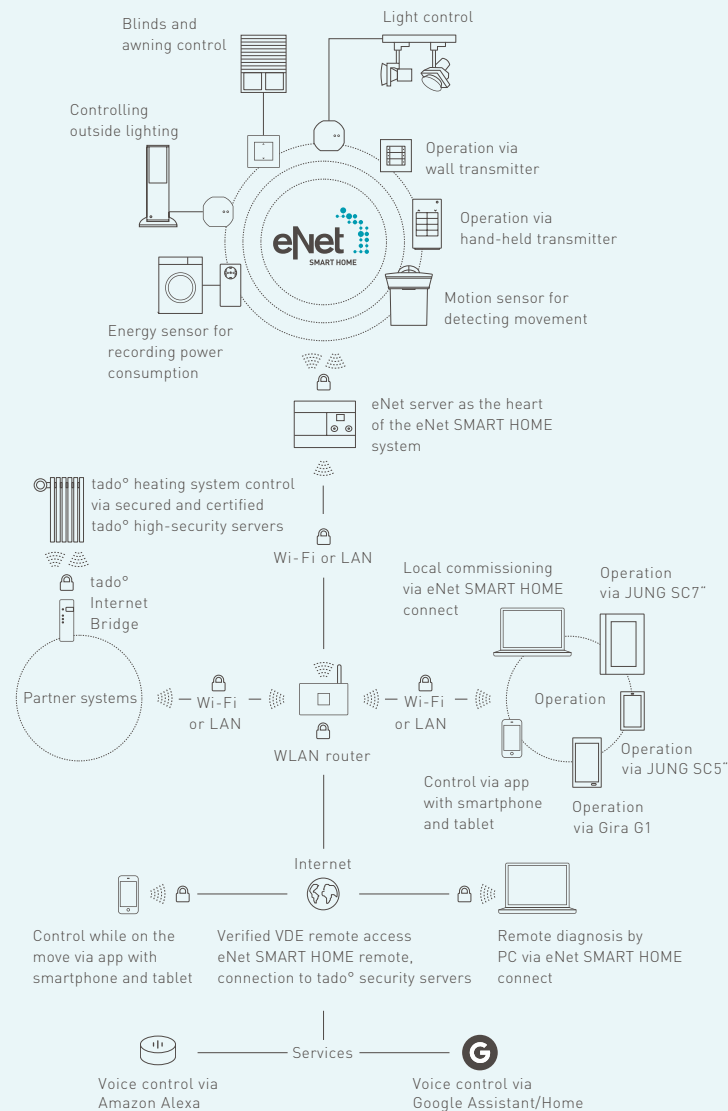

THE eNet CONVENIENCE SYSTEM

eNet SMART HOME is intended to make your everyday life easier. To do this, it needs an integrated system where all the units complete their tasks and complement one another. Let's take a look at how it works:

THE SERVER IS THE HUB.

The eNet server controls your connected appliances. It enables programming, visualisation and control. It records your power consumption using sensors and evaluates the data. So it's the heart of the system.



CONNECT IS A NEAT, NO-FUSS SOLUTION

Your specialist engineer commissions your system. This takes place thanks to eNet SMART HOME connect. The convenient commissioning interface is already integrated in the server. It makes installation a quick and easy process.



WITH THE APP, YOUR HOME IS WITH YOU ALL THE TIME

Control your home. Wherever you are. As you would usually do. The app is available for both the Android and iOS operating systems. You can download both apps for free.



REMOTE FREES YOU FROM LOCATION-BASED CONSTRAINTS

eNet SMART HOME remote allows you to control your home from anywhere. With the app, you always remain connected through remote access. It doesn't matter whether you're at home or not, as you can control your home from anywhere.



WITH SECURE, YOUR DATA BELONGS TO YOU

Convenience includes not having to worry about data security. This is why your specialist will activate the encrypted communication feature of eNet SMART HOME secure. eNet means convenience that you can trust.

FIVE PRINCIPLES MEAN FIVE REASONS FOR INSTALLING

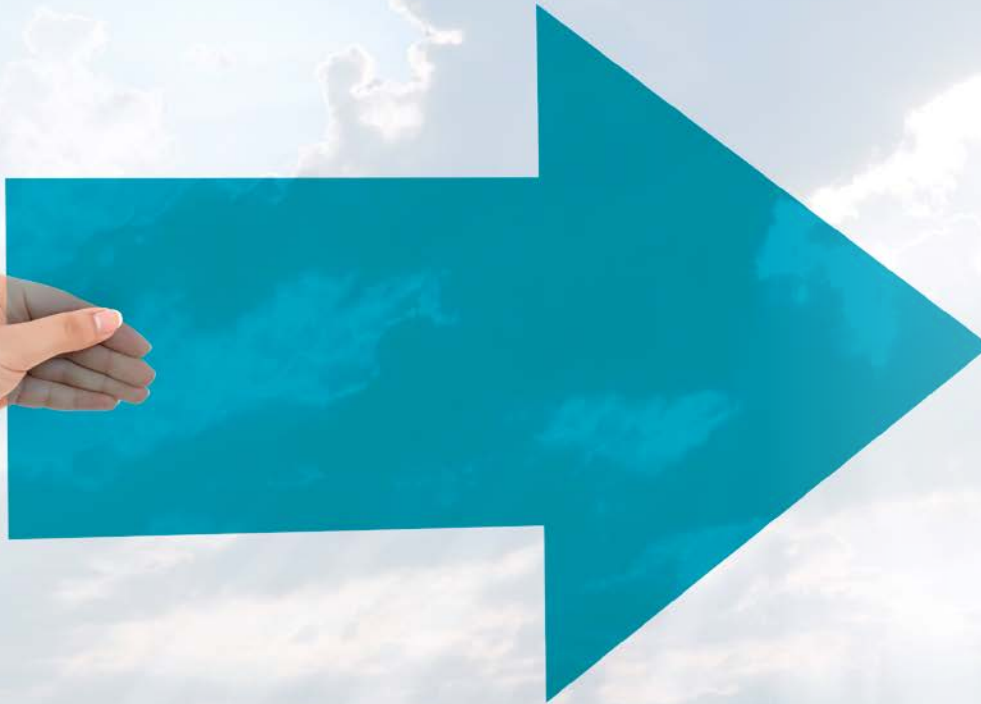

We have five rules. They are the guiding principles behind the way we think and create. These principles have one goal: ensuring total convenience for you.

BRAND PRINCIPLE

eNet SMART HOME links up powerful brands to form the eNet Alliance. Each of our partner brands focuses on their particular strengths, meaning that you get a future-proof system made up of individually dependable components that won't let you down.

SERVICE PRINCIPLE

A personal contact will be on hand to help you. Your specialist engineer will be by your side – from the initial consultation to the final installation. He or she will set up your smart home in accordance with your requests and requirements. And if you have any questions or want to upgrade later on, you will have a local specialist on hand.

FUNCTIONAL PRINCIPLE

eNet is user-friendly. It can be controlled intuitively, no matter whether you operate your smart home using a wall transmitter or the app. You don't need to spend hours learning how to operate the system. This means the system is suitable for everyone.

CONFIDENTIALITY PRINCIPLE

Your data belongs to you. Communication between the eNet server and appliances is encrypted. The data traffic between your smartphone and appliances is also encrypted. It's all the same whether you're controlling your smart home while at home or on the move. Software updates ensure that it will continue to operate securely in the long term.

FUTURE PRINCIPLE

eNet adapts to your life. Because our system is wireless-based, it is flexible. This means that you can upgrade it to suit your requests and requirements. You get a system that meets the highest standards and will continue to do so even in the future.

SETTING UP WITH ADVICE FROM THE SPECIALISTS

Regional specialist tradesmen are our strongest partners. Being eNet specialists, they can give you expert advice and professionally commission your system.

You don't need to worry about how to set up your smart home or which components go with your system. Our service partners in your local area will advise you. You will therefore have a personal contact for your entire smart home system. All eNet service partners have been given professional training to ensure that their knowledge of the products and applications is unparalleled.

Only careful and professional installation guarantees a reliable smart home. Your specialist tradesmen have been very well trained to plan and implement it for you.

Find your eNet service partner the easy way at www.enet-smarthome.com



CONTROL YOUR HOME

You can choose what control to use to operate your smart home. Control your home they way you want. By smart-phone, by wall button, by voice or completely automatically. Mobile, hands-free or the classic wall-mounted option. One options does not rule the other out.



CONTROL IN YOUR HANDS

Whether you are at home or not: A tap on your smartphone or tablet is all it takes for your home to do what you want. Thanks to the eNet SMART HOME app. The user interface is correspondingly adapted to iOS and Android. The app is therefore operated from your smartphone or tablet in the way you'll already be familiar with, which makes it completely intuitive.

Create scenes, time schedules and "If-Then" rules with the app. Set the most important appliances and functions as your favourites and have quick access to your favourite features.

We have already pre-defined convenience functions for you, so you can start controlling your home with the app straight away.

WALL-MOUNTED CONTROL

Our wall transmitters not only have impressive functions, but a captivating design too. After all, intelligence and good looks don't always have to be incompatible.

You can install the wall transmitters wherever is convenient for you. There are buttons on the wall transmitter, to which you can easily allocate your favourite functions and scenes. This means you can

put all your desired settings on a single switch.

Wall transmitters allow you to control the basic functions – even without a server. This means that your home will remain smart, even if (independently of eNet) your home network occasionally isn't. You can count on eNet SMART HOME.

PRACTICAL SOLUTIONS

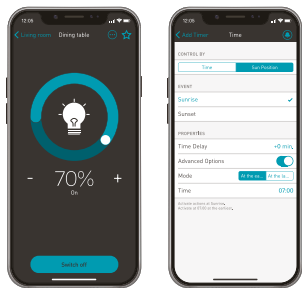

Let's move from theory into practice. eNet makes your everyday life more convenient. But what does that look like in specific terms? Let's take a look at the individual solutions:

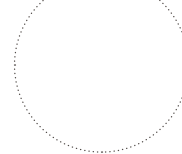

LIGHT CONTROL AT THE TAP OF A FINGER

A tap of your finger gives the command to turn all the lights in your home on or off. And if you'd like things a bit more romantic, then simply dim the lights down to the level you like.

SMART BLIND CONTROL

Lowering all the blinds one by one every evening. What a chore These laborious days are numbered – thanks to the eNet SMART HOME. Here, too, all it takes is a tap of the finger and day will become night.

TURN ON, TUNE IN, SET THE MOOD

Become the leading actor on your own stage. With the "Scenes" function, you can adjust appliances, light and blinds to one another, allowing you to trigger scenes that suit your mood perfectly.

YOU CALL THE SHOTS

Combine your devices any way you please and enjoy the benefit of voice control via Amazon Alexa or Google Assistant.

TRANSPARENT ELECTRICITY COSTS

Which of your appliances do you think are the biggest energy guzzlers? Your smart home calculates how much energy your appliances consumes giving you a simple overview of your household energy consumption. That way, you won't be in for any nasty surprises when you receive your next electricity bill.

FOR PEOPLE WITH FIXED ROUTINES

If you're a creature of habit, eNet is too. Simply program your smart home to do what you'd like it to at precisely the moment you want.

EVERYTHING OFF WHEN YOU'RE OUT

With tado°'s Away function, you can automatically have all the lights switched off, the blinds lowered and the heating turned down as soon as everyone has left the house.

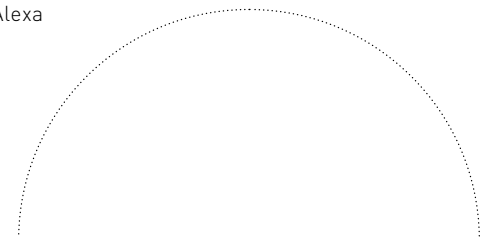

A SYSTEM FOR EVERYONE

eNet SMART HOME is a system that satisfies a multitude of requirements. Meaning everyone can benefit from it. That's also why we've made operation as intuitive as possible. In this respect, it doesn't matter how tech-savvy you are. Everyone can handle eNet.

01. DISCERNING USERS WELCOME

For those of us who attach the utmost importance to quality. After all, only the highest standard will do!

02. SERVICE – SIMPLY EVERYWHERE

Do you believe it is important to have a personal contact? Our service partners provide you with individual and competent advice.

03. EVERYTHING SAFELY UNDER CONTROL

Do you believe that protecting your data is important? We agree.

04. CONVENIENCE THAT EVOLVES WITH YOU

... is relevant for all those who want to organise their lives in a flexible way.

05. A RELAXED LIFE

... means support in everyday life. Your home supports you wherever possible.

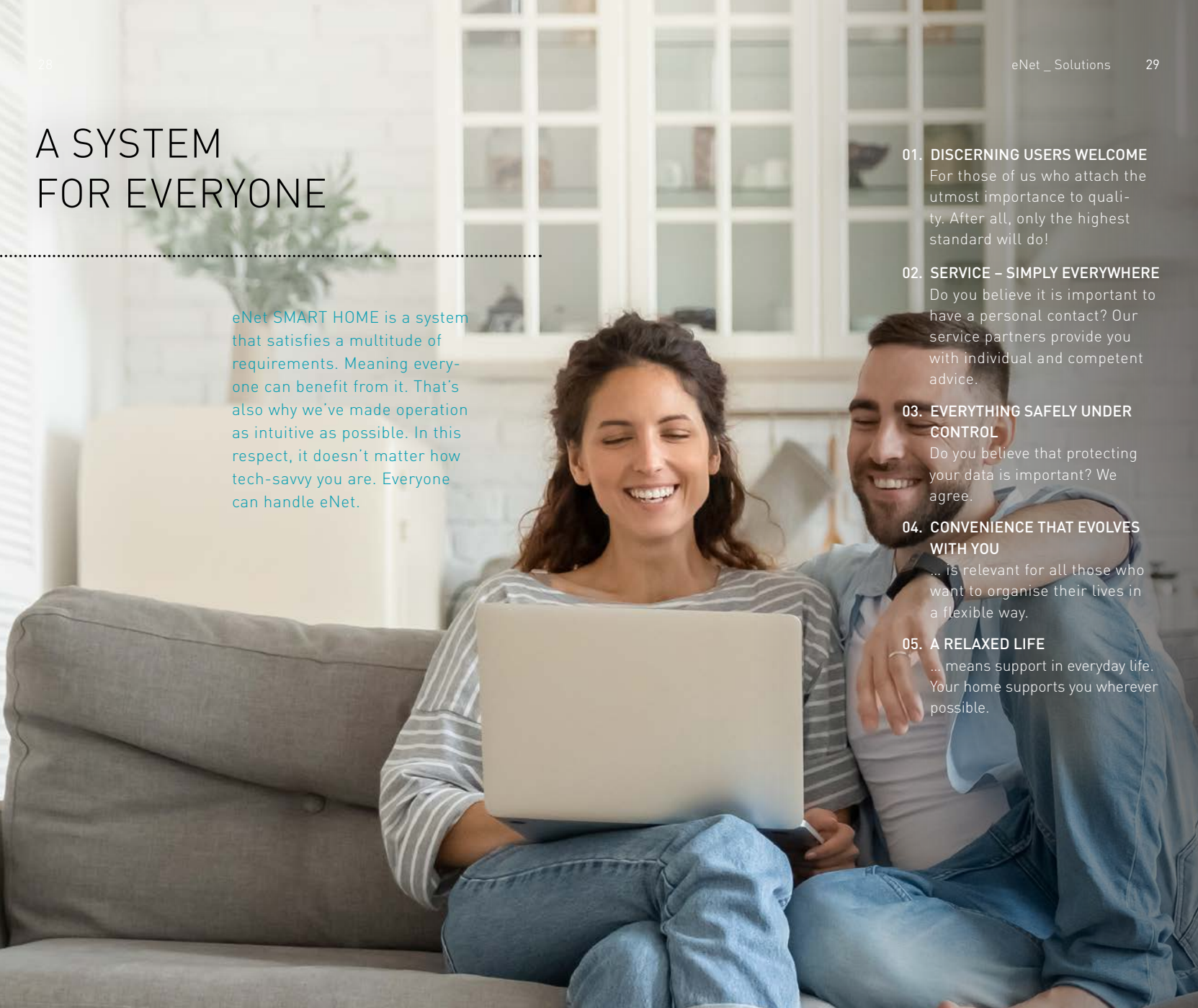

01. DISCERNING USERS WELCOME

Enjoy a convenient start to the day with eNet SMART HOME. Simply install a switch at your bedside and allocate it a scene that will give you a relaxed start to the day. For example: the blinds raise, the bathroom heats up, the slats in the bathroom adjust to give you complete privacy. And while you're showering, the coffee machine is already heating up, and the egg cooker is preparing

a delicious breakfast for you. It's the perfect hotel feeling – first thing in the morning. Ultimately, you don't need to worry about a thing any more, because your home looks after you.

Even after the working day has drawn to a close. Create scenes that suit your mood. You can synchronise all the appliances that

have a plug with one another and then set up scenes conveniently using the app.

And selecting designs for the wall switches is convenient too. All you have to do is choose the model that suits you and your style.

eNet SMART HOME turns everyday living into something special.



02. SERVICE – SIMPLY EVERYWHERE

Smart Home – would you prefer to call the professionals in instead of doing it yourself? Then eNet SMART HOME is your first choice.

You will find service partners in your local area on our website (www.enet-smarthome.com). All you have to do is arrange a non-binding consultation. Our partners will advise you and turn your requests and

requirements into functions. The installation process is then carried out professionally and quickly by a specialist. Without any need to prise open walls or make a mess. And if you'd like to upgrade or have any questions, then your service partners are there for you even after installation is complete.

From now on, you can enjoy the service your home offers you. Set scenes that will allow you to unwind after a hard day's work. Or add a cosy touch to your home while you're still on the move. And if you're ever unsure whether you really switched off all the appliances, all you have to do is check on your smartphone and switch off any appliances that are still on.

eNet SMART HOME is service that you can trust.

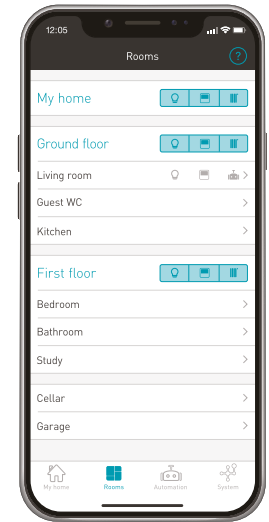
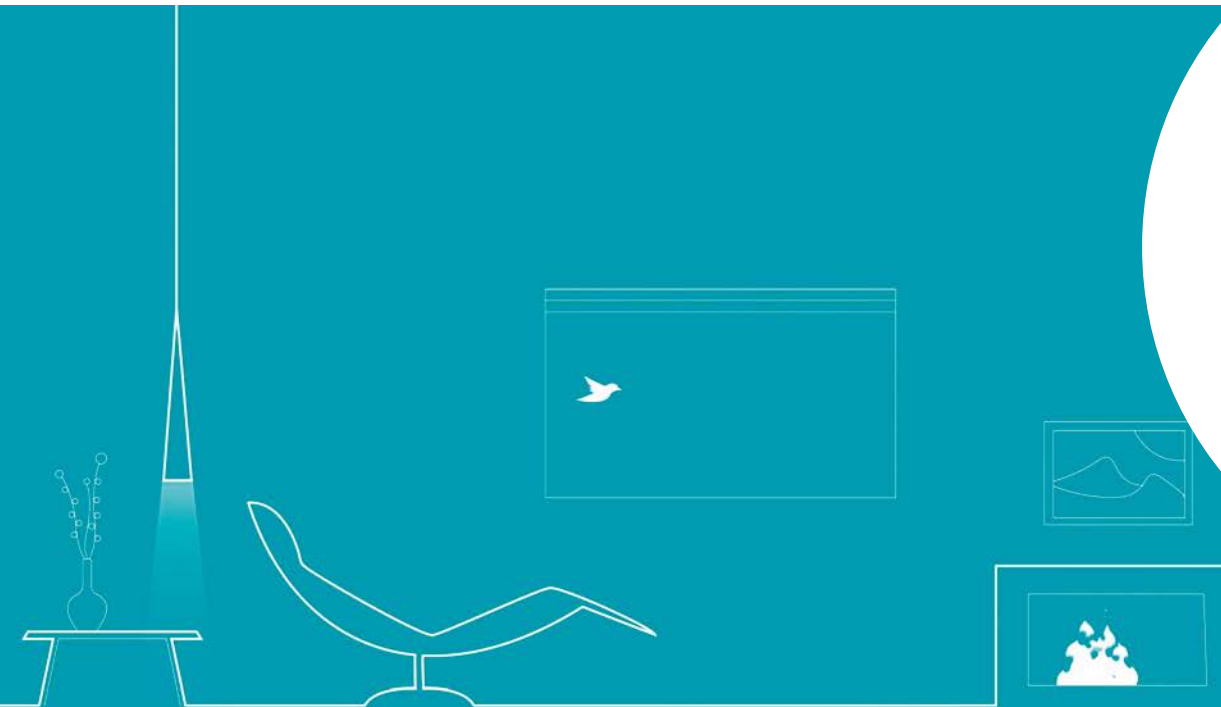

03. EVERYTHING SAFELY UNDER CONTROL

With eNet SMART HOME, you can smarten up your business as well as your home. Turn your office into a smart office – the easy way.

Then you can wake up your workplace while you're on the way in. With just one tap on the app. Then the blinds will raise, the heating,

lights and printer will switch on, and the coffee machine will be ready and waiting for you. This means that you save time first thing in the morning.

If the sun gets brighter, the slats in the blinds will adjust automatically. And if it gets darker again, the

lights will switch on automatically. This saves both energy and costs! And with the right lighting concept, annoying glare will also be a thing of the past. And as a result, you can work in complete convenience. And the energy-saving features don't stop here. eNet SMART HOME measures your devices' energy

consumption, allowing you to locate energy guzzlers quickly.

eNet SMART HOME also keeps your data safe. Because with secure, communication between all the devices is fully encrypted. No matter where you're controlling the office from.

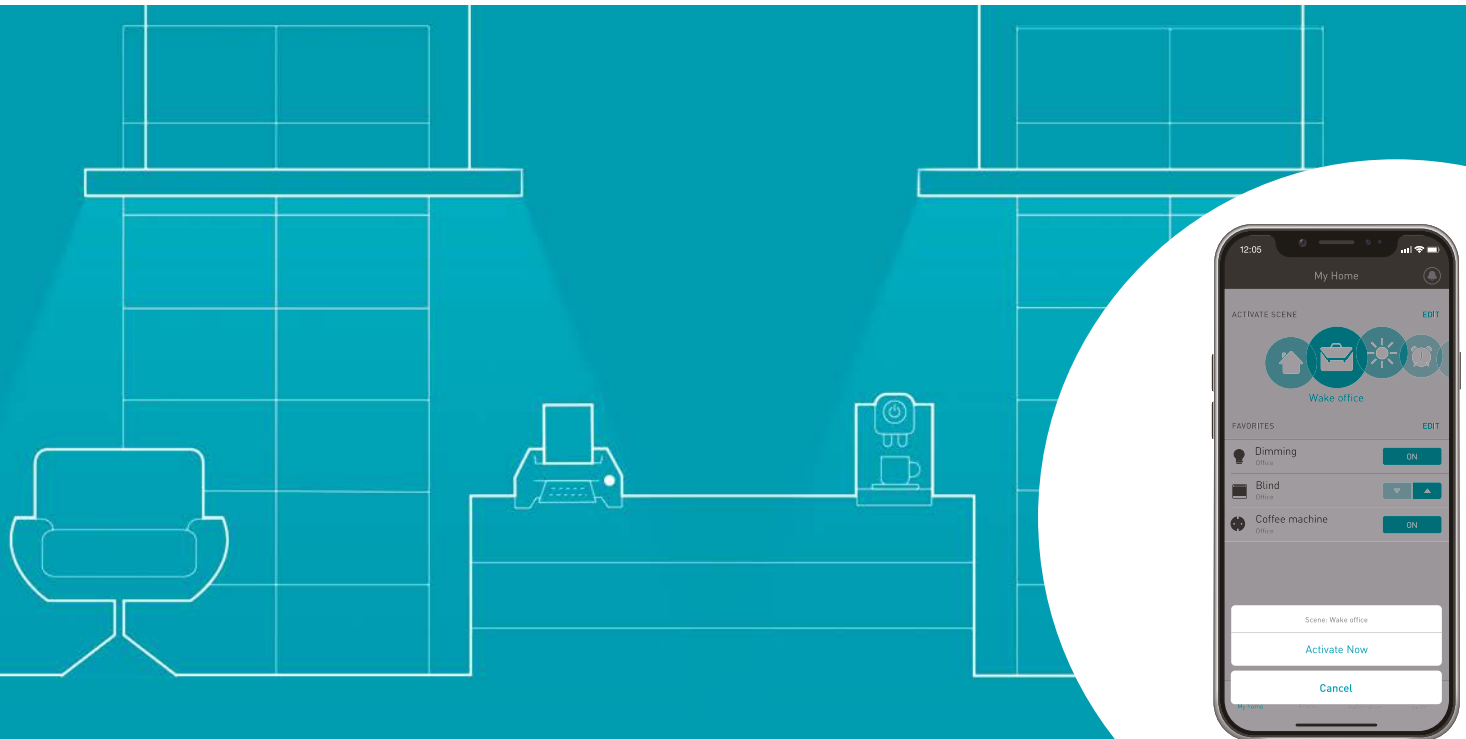

04. CONVENIENCE THAT EVOLVES WITH YOU

Would you like a future-proof smart home?

eNet SMART HOME is based on wireless communication and is designed so that you can gradually upgrade functions. Whenever you want and whenever it fits in with your life.

Everything that leaves our workshop – both now and in the future – can be easily integrated into your existing system. We rely on interdisciplinary cooperative relationships to ensure that your smart home can be equipped with exactly the functions that suit your life.

New partner brands contribute new products and functions. Which means that our range of solutions is growing.

What you get, then, is a system that satisfy your future requirements too.

And if you already know that you'll be moving home sometime in the future, that won't get in the way of eNet SMART HOME. Because you can take it with you.

Adapt your home to your life. Extraordinary circumstances call for extraordinary measures.

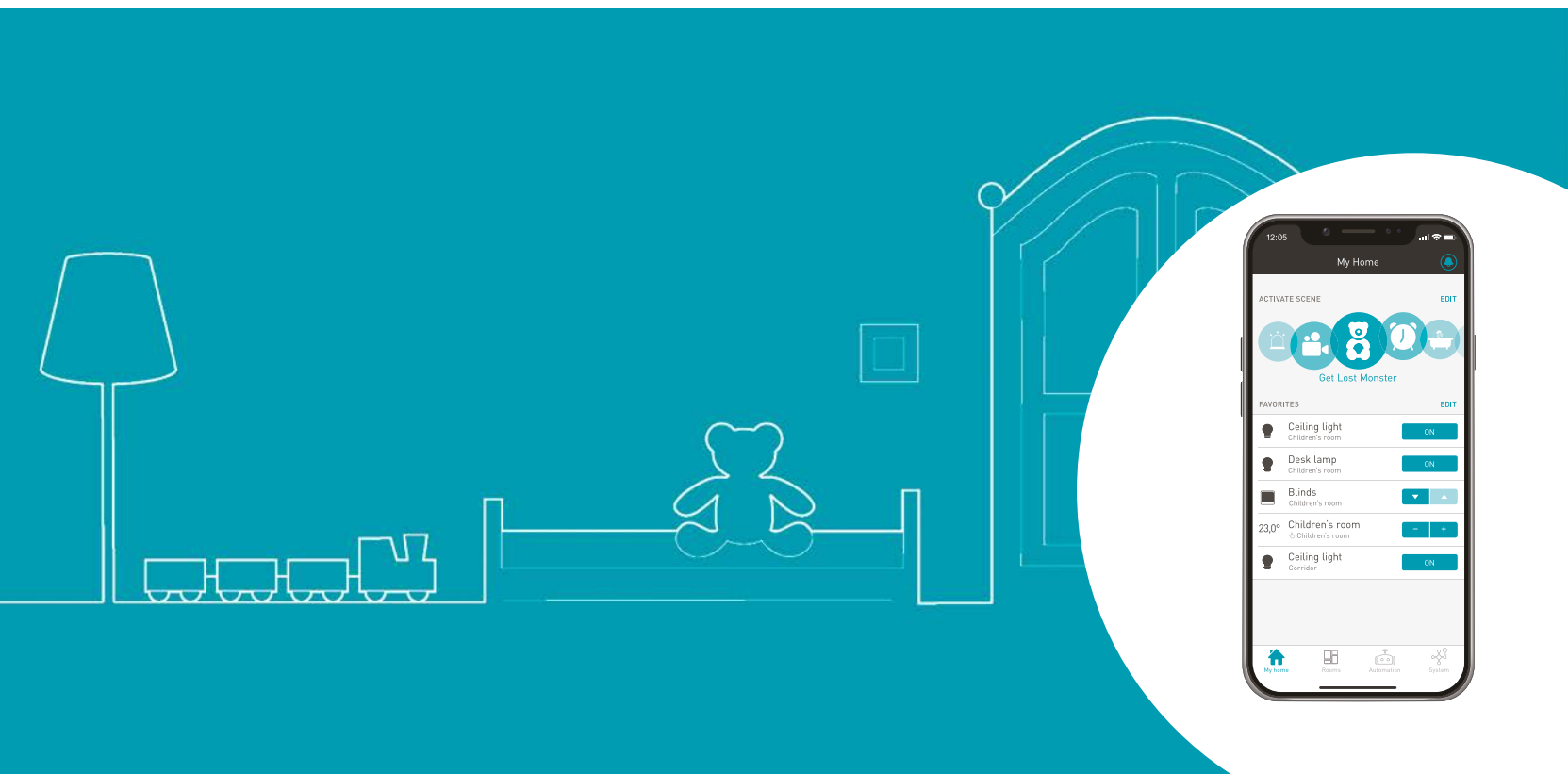

05. LIVING A MORE RELAXED LIFE

To make your life more relaxed, your home takes some of those everyday tasks off your hands. For example, you no longer need to adjust your blinds individually. All you need to do is tap your smartphone or the wall transmitter, and your home will do it for you. And if you want, eNet SMART HOME will even do this automatically

according to a predefined schedule. All you need to do is set the action once. Integrate your garden into the system too. Eliminate tripping hazards by incorporating motion detectors. As soon as someone enters your premises, path and garden lights will switch on. Control individual functions with

your smartphone or tablet. Would you like the blinds in a certain room to lower and the heating and lights to be switched on? No problem!

This can also be done using the wall transmitter. Even when you're offline.

And you don't need to worry that the system might be complicated to operate. Controlling the wall transmitter and app is completely intuitive. Things get even simpler with spoken commands via your Alexa or Google device. After all, living isn't meant to be complicated.



QUALITY THAT EXCEEDS LEGAL REQUIREMENTS

Your satisfaction is at the heart of what we do.

And for that very reason, we always try our best and satisfy requirements that exceed the legal provisions in many industries. This is our way of guaranteeing you the highest quality.

Our products stand for:

HIGH PERFORMANCE

We have many years' experience in building technology, from which we have acquired extensive expertise. This is why many of our products are based on patented procedures and circuits.

If the overall package is to fit the bill at the end of the day, every single component in the system must work. And that's why we only use components of the highest quality.

ABSOLUTE RELIABILITY

We would like to offer you a system that you can depend on. That's why our system is far more resistant to overvoltage than the legislation requires, for example.

We naturally check each and every device to ensure it is in good working order. No product leave our production facilities unchecked. That way, we ensure that our products work the way they should.

AND DURABILITY

Not only do we choose the best components; we carefully select our suppliers too. In this way, we ensure an outstanding long-term product availability.

To ensure that the devices communicate perfectly and that you can therefore enjoy the products for many years to come, each and every wireless product goes through a frequency alignment before delivery.



eNet LINKS UP POWERFUL BRANDS

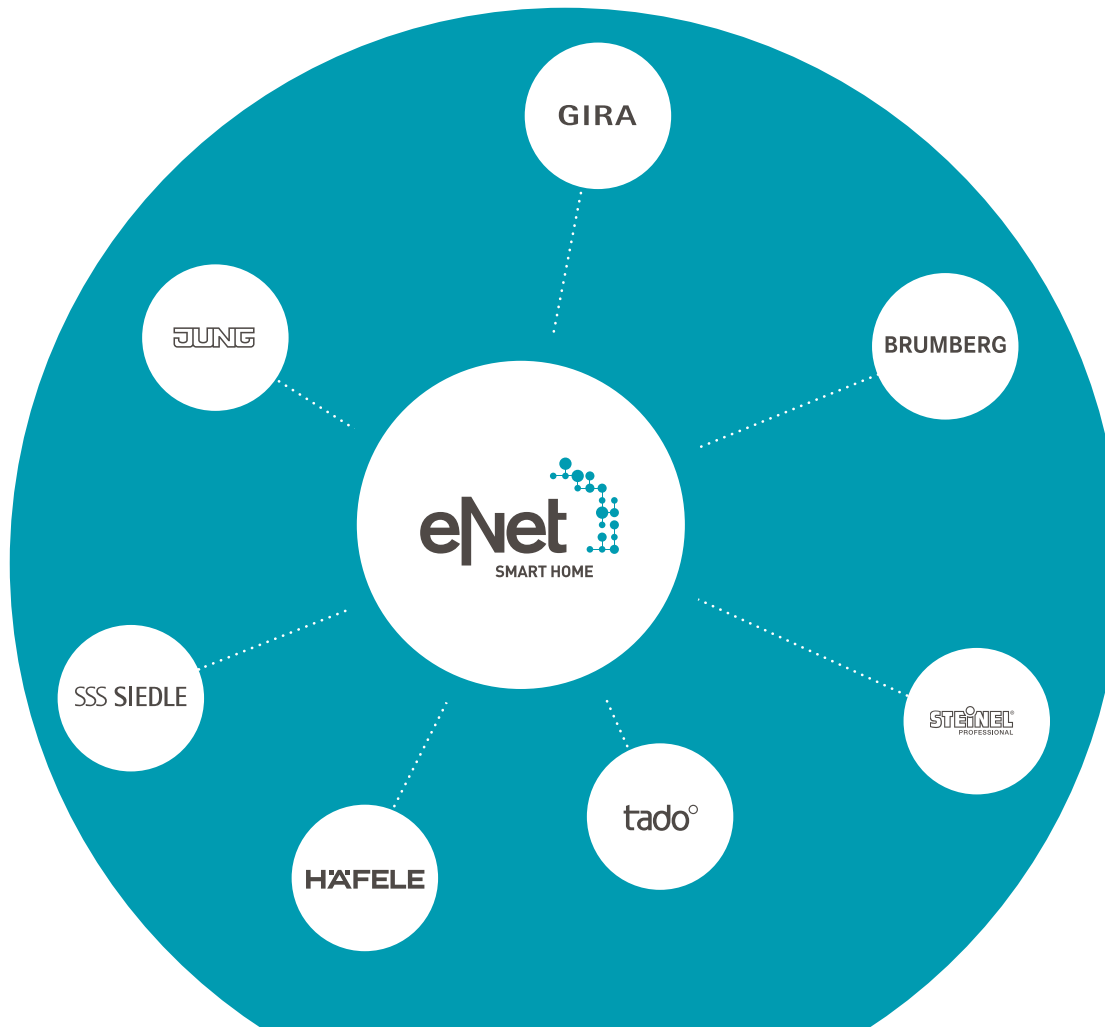

The idea behind eNet SMART HOME is to offer our customers a versatile, high-quality home control system. To ensure that all the components meet our stringent standards, we have created a cross-manufacturer collaborative partnership. The eNet Alliance. Comprising Brumberg, Gira, Häfele, JUNG, Siedle, STEINEL Professional and tado° Professional.

Our partners are reputable manufacturers in their specialist fields. And we have pooled their expertise in eNet SMART HOME. This is why quality is an integral feature not simply of each and every component, but of the system as a whole.

All eNet devices can be wirelessly networked with one another with ease. You can turn individual requests and requirements into a reality – the easy way.

We work tirelessly to scale up our system and to add new partners to our Alliance. After all, new partner brands bring new applications to the table for you. This willingness to cooperate and open-mindedness lays the foundations for convenience that you can trust in the long term.

You will find all the Alliance-related news at www.enet-smarthome.com

GIRA

The name Gira is synonymous with systematic modern building technology that makes living more convenient, more secure and more energy-efficient. To this end, Gira offers intelligent functions and user-friendly devices for the easy and convenient control of lighting, heating and blinds, as well as door communication, multimedia and security systems.

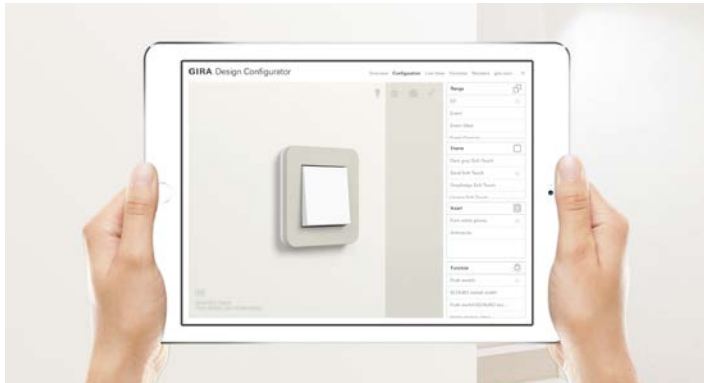

Gira System 55 – the modular system with more than 300 functions. The Gira System 55 combines a wide range of modern building technology functions with a diverse selection of design variants.

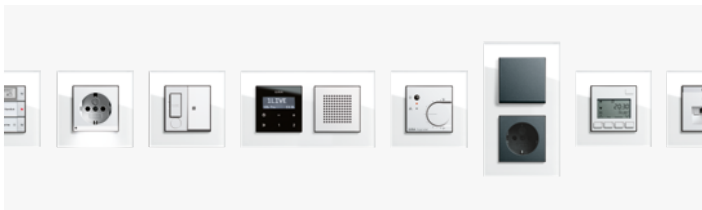

Outstanding switch ranges with top-quality design standards provide the perfect frame for integrating your eNet functions. Discover the world of Gira at www.gira.com. Even better: try out your favourite design right now. The Gira Design Configurator with augmented reality makes this possible.

The battery-operated wireless wall transmitters can be conveniently positioned wherever switches or push-buttons are needed, regardless of the fact that the mains connections have different design variants. They can either be mounted on the wall with screws or be conveniently attached to smooth surfaces such as panes of glass using adhesive strips.

The wireless operating top units are easy to install and can make a conventional electrical installation wireless-enabled.



JUNG

For over 100 years, the JUNG brand has stood for progressive, future-proof building technology that is "Made in Germany". With clever solutions in attractive designs, we create the perfect conditions for modern living and working. Our design standards follow a simple approach: Timeless, but not boring. Elegant, but not prissy. Modern, but not trendy. Aesthetic, but not ostentatious. Genuine materials, clear shapes and a harmonious choice of colours create a harmonious whole: the JUNG design.

The JUNG eNet wall transmitters follow these requirements too. Here, diversity of design and materials go hand-in-hand with the intuitive operating concept.

The JUNG wall transmitters are exclusively available around the world in the 63 original Les Couleurs® Le Corbusier colours. Find out more and visit the website of JUNG at www.jung.de/en/



Les Couleurs®
Le Corbusier



Individual wall transmitters are created by labelling the buttons with symbols or text using the JUNG Graphic Tool.



Wall transmitters in the F 40 and F 50 ranges are available in 1-gang to 4-gang versions.



Large buttons characterise the design of the F 40 wall transmitters.

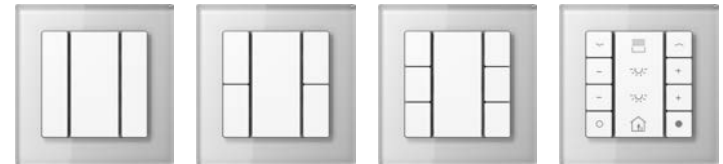

The F 50 wall transmitters, meanwhile, have space for labels on the eye-catching information field.

Overview of eNet SYSTEMS



eNet AND eNet SMART HOME

eNet and eNet SMART HOME are synonymous with the expansion stages in modern electrical installation. Optimised for domestic installation in new buildings as well as for retrofitting in old buildings, – simple to put into operation, no complicated commissioning software, tailored to the needs of tradesmen and electricians alike.

eNet and eNet SMART HOME are two distinct worlds in a single system. The devices carrying the eNet or the eNet SMART HOME logo – or both – form the technical basis of this. eNet devices communicate wirelessly and do not depend on cables between the operating station and switching device. There is no need to position operating stations in places where cables are present; rather, they can be installed wherever they are easily accessible. The actual switching devices are situated wherever the cables lead to lights or roller shutters, in other words in the flush-mounted socket or directly in the sub-distributor.

1. eNet

eNet is the technical equipment standard for wireless networking in building technology. Devices networked using eNet can be incorporated in the eNet SMART HOME world at any time by adding an eNet server, as long as it also features the eNet SMART HOME logo.



eNet bridges the gap between conventional technology, where devices are wired individually, and

Two “worlds”, one system

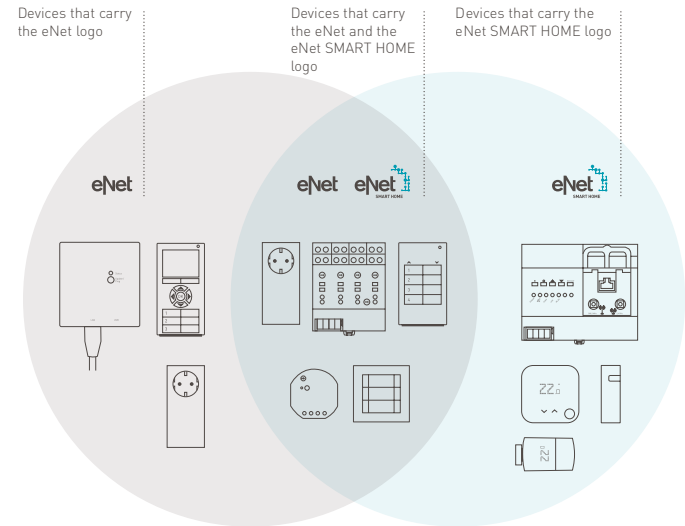

networked building systems technology, which is now an integral part of functional building. eNet does not require any additional training effort and solves small and medium-sized applications in modern building technology.

The result of this is:

- sophisticated devices for building installation
- simple retrofitting
- quick installation
- easy commissioning
- flexibility for the future

From comprehensive functions for lights and blinds, to simple smartphone-based control, eNet satisfies many customer requirements.

Connecting eNet transmitters and actuators – the easy way

MANUAL COMMISSIONING

1. Press the programming button on the actuator. The actuator flashes.
2. Press the programming button on the transmitter. The transmitter flashes.
3. Press the desired operating button on the transmitter. The transmitter and the actuator save the connection.

2. eNet SMART HOME

eNet SMART HOME is the advanced expansion stage for contemporary operation via smartphone or tablet, locally or via remote access, secure, fully encrypted communication and additional convenience functions that end customers can use and manage flexibly.



The learning curve is minimal for installing an eNet SMART HOME system too – as the installation engineer can pick up the necessary knowledge in the space of a day.

With eNet SMART HOME, the system is expanded to include the following features:

- eNet SMART HOME app
- eNet SMART HOME connect
- eNet SMART HOME remote
- eNet SMART HOME secure
- Voice control via Amazon Alexa
- Voice control via Google Assistant / Google Home

Individual adaptations to personal requirements are therefore in the customers' hands, as they can perform many functions – such

as timing functions, for example – with their smartphone or tablet. For the customer, this means smart, understandable functions, comprehensive comfort, excellent efficiency and fantastic flexibility.

eNet SMART HOME
app start screen

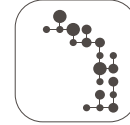
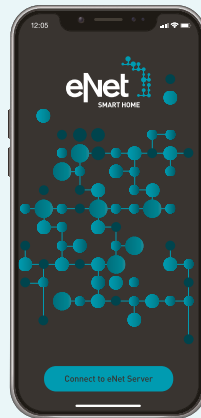

eNet SMART HOME app

The app is available in versions for Android or iOS and supports control of the eNet SMART HOME system via smartphone or tablet. It is easily operated from the local network at home or can be accessed remotely via the internet.



eNet SMART HOME remote

You can also conveniently operate the eNet system while on the move by using the app and the fully encrypted remote access solution, eNet SMART HOME remote.

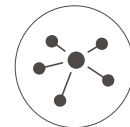

eNet SMART HOME connect

With this convenient, browser-based commissioning interface, the installation engineer can connect eNet transmitters and actuators, set parameters and priorities, define threshold and blocking functions and perform diagnostics operations.



eNet SMART HOME secure

With eNet SMART HOME secure, the system is protected by a complete package of security measures. In addition to fully encrypted wireless transfer, these measures include data security, a server location in Germany and tamper-proofing.

3. FEATURES OF eNet AND eNet SMART HOME

	eNet	eNet SMART HOME
Encrypted communication	-	✓
Manual commissioning	✓	-
Commissioning with eNet SMART HOME connect	-	✓
Smartphone-based operation	<ul style="list-style-type: none"> • JUNG eNet IP gateway app • GIRA eNet mobile gate app (prerequisite: IP gateway) 	eNet SMART HOME app
Operation via tablet and signal panels	-	eNet SMART HOME app
tado° Professional	-	✓
Scenes:		
• Calling up	✓	✓
• Changing values	✓	✓
• Adding/ removing devices	-	✓
Automatic functions:		
• If-Then rules	-	✓
• Timing	-	✓
Setting device parameters	(Configuration via eNet server possible)	✓
Blocking functions	(Only with hand-held transmitter display)	✓
Threshold functions	(Only with sun/ twilight sensor)	✓
Restraint	(Only with hand-held transmitter display)	✓
Lock-out protection	(Only with hand-held transmitter display)	✓
Updating software	-	✓
Backing up project data	-	✓
Documenting a project	-	✓
Recording telegrams	-	✓
Measuring signal quality	(Only with diagnostic device)	✓
Remote access via app	-	✓

4. SENSORS AND ACTUATORS

The sensor/actuator concept has become well-established in building technology.

- Sensors record information from their surroundings and send out electrical signals.

Example: Pressing a button on a switch.

- Actuators receive electrical signals and carry out corresponding actions.

Example: Dimming a lamp.

One sensor can normally trip several actuators, and one actuator can be operated by several sensors.

Hand-held and wall transmitters are always sensors too.

Wireless transmitters and wireless receivers – sensors and actuators

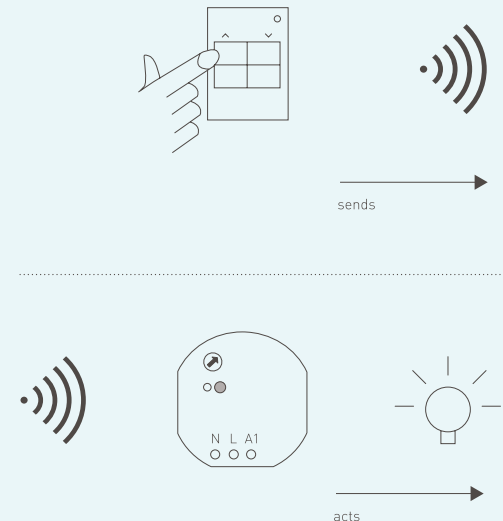

OVERVIEW OF DEVICES

1. eNet WALL TRANSMITTERS AND OPERATING TOP UNITS

Examples of wall transmitters

Battery-operated wall transmitters can be positioned everywhere they're needed.

Gira eNet 1-gang wireless wall transmitter

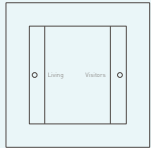

Gira eNet 3-gang wireless wall transmitter

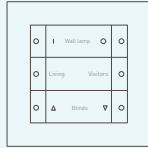

JUNG eNet 1-gang F 50 wall transmitter

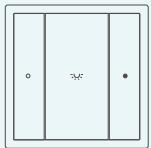

JUNG eNet 3-gang F 50 wall transmitter



Wall transmitter installation diagram

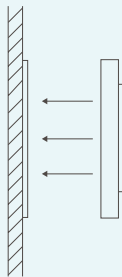

Examples of operating top units

Operating top units make conventional electrical installations wireless-enabled.

Gira eNet wireless switching/dimming top unit, 1-gang System 2000

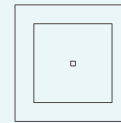

JUNG eNet radio centre plate top unit, 1-gang

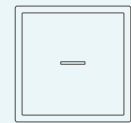

Gira eNet wireless blind control button, 1-gang

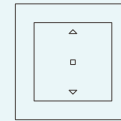

JUNG eNet radio centre plate for blind control

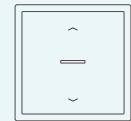

Gira eNet wireless operating top unit Memory

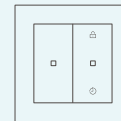

JUNG eNet radio centre plate (for LB management)



Gira eNet wireless operating top unit

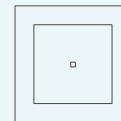

JUNG eNet radio centre plate Standard

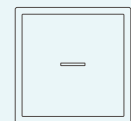

Flush-mounted insert
installation diagram

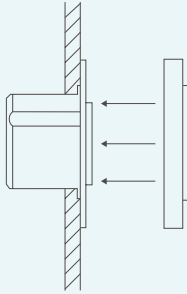

2. eNet HAND-HELD TRANSMITTERS

Building technology can be controlled using various types of hand-held transmitter.

Hand-held transmitter, 1-gang

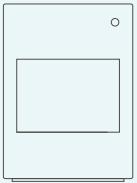

Hand-held transmitter, 2-gang

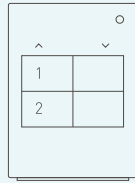

Hand-held transmitter, 4-gang

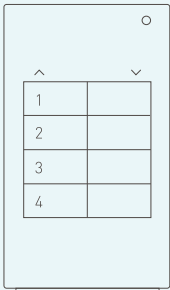

Hand-held transmitter display*

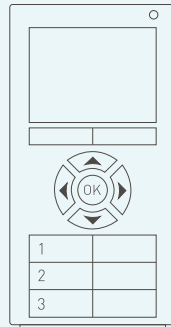

* Not compatible with eNet SMART HOME – cannot be used with the eNet server

3. OPERATING PANELS

Fixed operating panels for wall mounting enable control and configuration of the entire eNet SMART HOME system.

JUNG Smart Control 5"

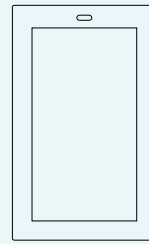

JUNG Smart Control 7"

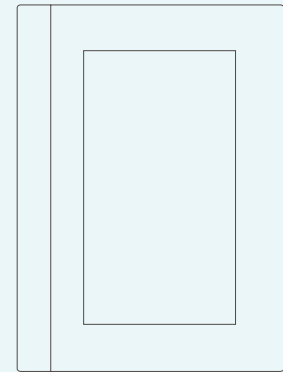

Gira G1

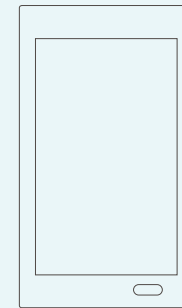

4. eNet DEVICES IN THE MINI HOUSING

eNet devices in the Mini housing can be concealed in flush-mounted or surface-mounted device boxes.

Examples of devices:

Actuators:

- Blind actuator, 1-gang Mini
- Switching actuator 2-gang Mini
- Switching actuator, 1-gang Mini
- Switching actuator, 1-gang Mini potential-free
- Dimming actuator, 1-gang Mini
- DALI control unit, 1-gang Mini
- Control unit 1 – 10 V, 1-gang Mini

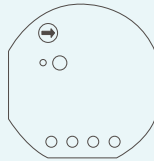

More:

- Energy sensor, 1-gang Mini
- Universal transmitter, 2-gang Mini

Accessories:

Mini housing installation adapter for mounting in intermediate ceilings and for surface mounting on DIN rails.

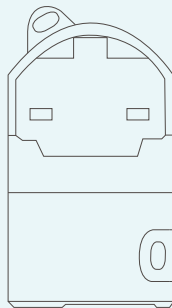

5. eNet DIN RAIL-MOUNTED DEVICES (DRAS)

eNet server

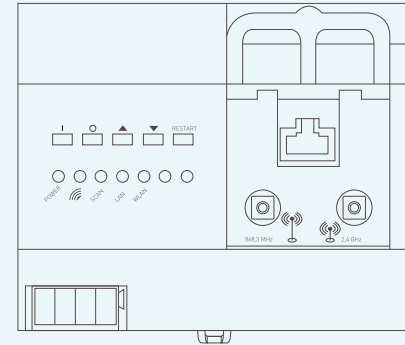

REG wireless receiver module

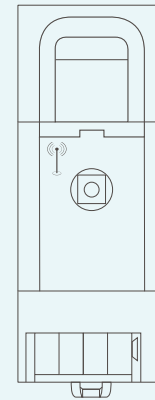

REG actuators and REG energy sensor

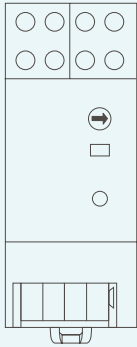

Examples of devices:

- Switching actuator, 1-gang DRA
- Blind actuator, 1-gang DRA
- Dimming actuator, 1-gang DRA

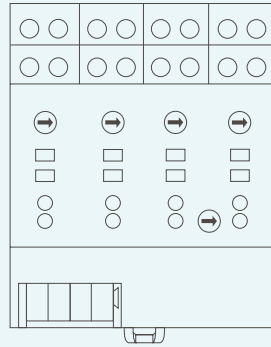

Examples of devices:

- Switching/blind actuator, 8/ 4-gang DRA
- Energy sensor, 4-gang DRA

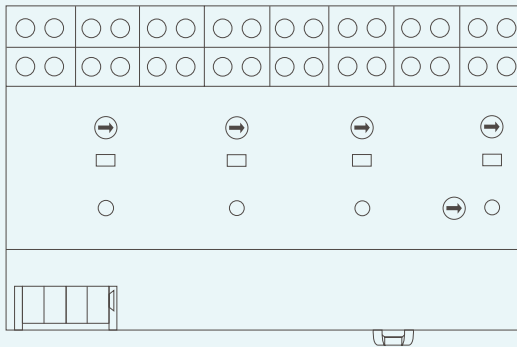

Examples of devices:

- Dimming actuator, 4-gang DRA

6. eNet ADAPTER PLUGS

Adapter plugs are suitable for mobile use. Wherever a switching function is to be controlled.

Examples of devices:

- Adapter plug for switching actuator*
- Adapter plug for energy sensor*
- Adapter plug for repeater*

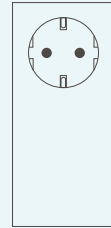

* No longer available for reorder.

7. PHYSICAL SENSORS

Sun/twilight sensor Solar

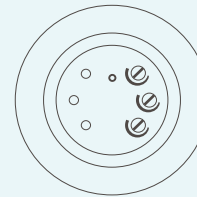

JUNG eNet motion detector

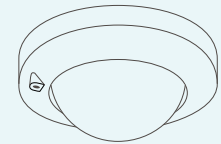

Examples of devices: Motion sensors

STEINEL XLED PRO eNet

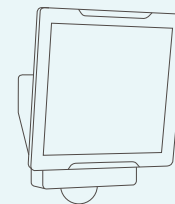

STEINEL SensiQ eNet

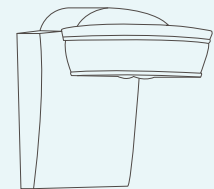

8. ENET HEATING SYSTEM CONTROL

tado° Bridge



tado° Extension Kit

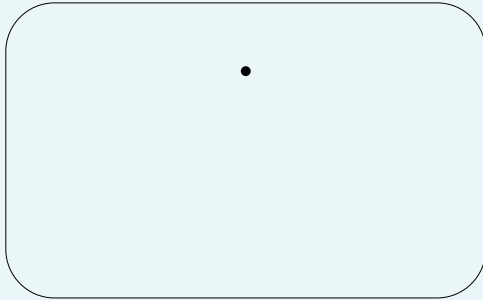

tado° Smart Thermostat

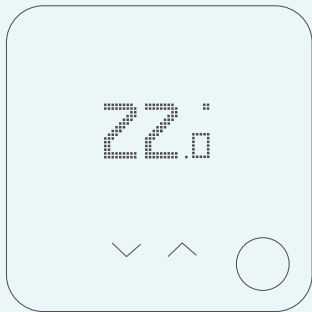

tado° Smart Radiator Thermostat

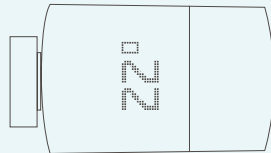

9. OTHER eNet DEVICES AND DESIGNS

Diagnostic device*

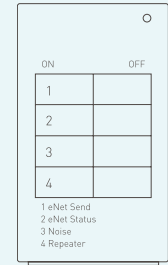

Antenna

Accessories:

An external antenna with magnetic base enables wireless reception when installation conditions are unfavourable, e.g. a metallic distribution cabinet.

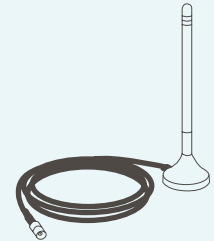

* Not compatible with eNet SMART HOME – cannot be used with the eNet server

SWITCHING, PRESSING AND DIMMING

Switching, pressing and dimming are the basic functions in every electrical installation.

1. SWITCHING AND PRESSING

Switching actuators contain a relay for switching loads such as lamps on and off. Switching actuators are equally suited to switching or pressing functions and can therefore be used as push-button actuators too. The operating mode is set during the commissioning process, e.g. using the operating mode switch.

An extremely wide range of loads can be connected to switching actuators and push-button actuators,

as long as the technical data of both the actuator and the load is compatible, e.g. light bulbs, HV or LV halogen lamps, fluorescent lamps, compact fluorescent lamps, energy-saving lamps, LED lamps and fan motors.

The Switching or Pressing operating mode is set directly on the device. In the PC position, the operating mode is predefined with the eNet server.

Switching function

During switching operations, the actuator is operated in a bi-stable

manner: A switch-on signal moves the relay permanently into the active state, while a switch-off signal moves the relay permanently into the passive state.

Push-button function

The Pressing operating mode is suitable for switching impulse switches or signal generators. During this process, the switching relay only remains in the active state for as long as the sensor element is being pressed. Once the pressing has stopped – after 60 seconds at the latest – the relay reverts to the passive state.

In both operating modes, the actuator can operate as an N/O contact or as an N/C contact.

Additional functions

The eNet server can also be used to set time functions such as switch-on or switch-off delays, which postpone the switching reaction, or timers, which automatically switch back to the passive state once the set time has elapsed.

2. DIMMING

Dimming devices are used to adjust the brightness of electric lights. Depending on the light type, the eNet system includes universal dimmers or, for lamps with an

Switching actuator with push-button function

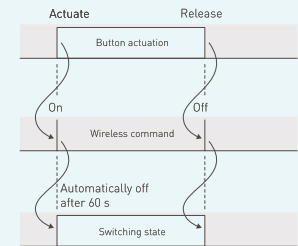

N/O contacts, N/C contacts

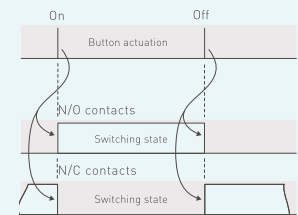

Switching with switch-on delay, switch-off delay or staircase lighting time switching function

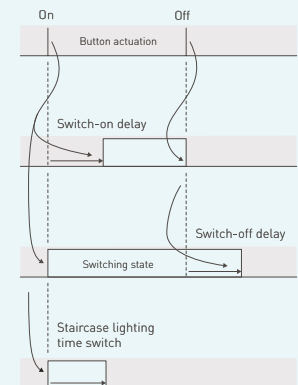

Switching actuators – examples

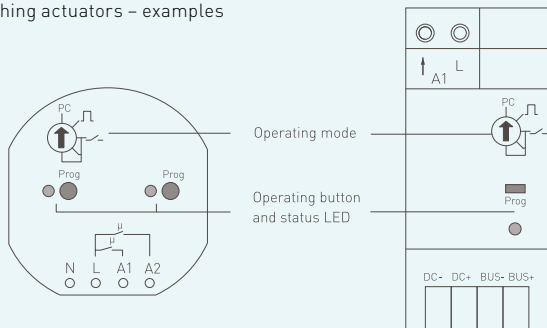

electronic operating device, control units for DALI or 1–10 V control.

Universal dimmers

In addition to the classic lamp technology, the universal dimmer is also suitable for dimmable HV LEDs or LV LEDs with transformers.

Universal dimmers detect the characteristics of the connected load and independently select the appropriate dimming principle – leading edge phase control or trailing edge phase control.

On the device, the dimming principle can be specified using the operating mode switch.

1 – 10 V or DALI operating devices

Lamp operating devices with a 1–10 V or DALI interface control the lamp brightness directly in the electronic ballast (EB). Brightness control units are used for this purpose.

3. BUTTONS FOR SWITCHING/DIMMING INSERTS

Adding eNet operating top units to the flush-mounted inserts turns the inserts into eNet actuators. This button contains a transmitter/receiver module, and transmits the commands received from the eNet transmitters to the insert and transmits the actuator status back to the transmitter. This combination

can be operated on the button itself, using connected push-buttons or auxiliary unit inserts, or using transmitters or the eNet server.

a higher-level command is adjustable – depending on the actuator type.

4. LIGHT CONTROL HIERARCHIES

A higher-priority command remains active until it is cancelled by the same or a higher hierarchy level. Lower-priority commands are blocked during this time.

Commands that were not executed previously are not subsequently executed once a higher-level control is cancelled. Generally speaking, the device behaviour at the end of

Device setup:

1. Flush-mounted insert
2. Cover frame
3. eNet operating top unit
4. Status LED

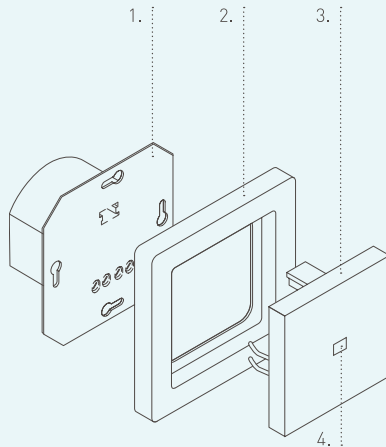

Light control priority system

Priority	Control hierarchy
1. (Highest)	Operating mode switch
2.	Restraint No lower-priority commands are executed
3.	Local operation With the operating button, for example. Lower-priority commands received following local operation are then executed.
4.	Local automatic system
5.	Commands received wirelessly
6. (Lowest)	Scene

AUTOMATIC LIGHT

Nowadays, nobody wants to do without the convenience of the light on the front door automatically switching on when they arrive home after dark. This makes it easier to get up the steps and unlock the front door.

This is made possible by motion detectors, which have become an integral part of every good building installation. They are successfully used in all areas where there is a lot of brief coming and going. To name but a few examples, these include:

- Entrance areas and paths leading up to homes
- Hallways and staircases
- Car ports and garages.

Not only do these lights provide convenience and security, they also help save electricity and their dynamic design creates an attractive atmosphere both around and in the building.

THE FUNCTION IN DETAIL

The basic function of an eNet motion detector lies in the precise detection of motion and the subsequent switching on of actuators. Depending on the device design, an actuator can either be integrated directly into the motion detector or be wirelessly networked.

eNet motion detectors measure the ambient brightness too. This function can be used to only switch on actuators when motion is detected, and if the brightness threshold also falls below a certain value.

Every time they detect motion, eNet motion detectors transmit the run-on time set on the device or using the server commissioning process to the connected actuators. Once

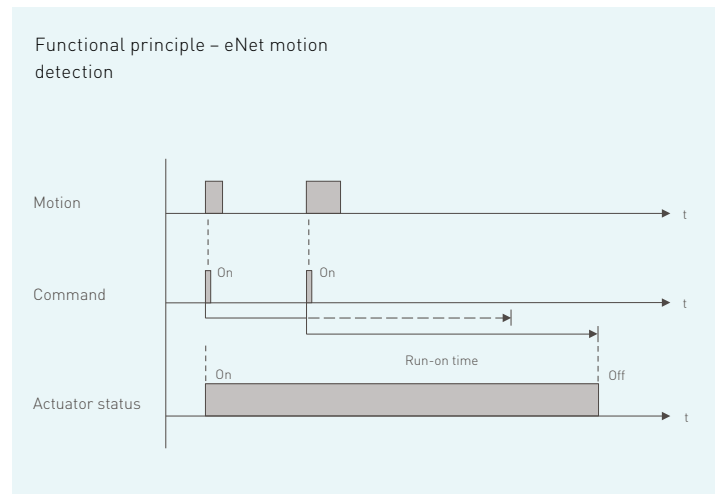

the run-on time has elapsed, the actuators automatically switch their loads back off again. If an actuator receives commands with different run-on times from several connected motion detectors, the longest run-on time always applies.

If the actuator receives switching commands from sensors that do not send run-on times, such as wall transmitters or sentinel auxiliary units, it calculates the resulting run-on time using the fixed run-on time that was programmed in during commissioning. However, the principle of the longest run-on time being used still applies.

An actuator that is already switched on extends its run-on time to include each new instance of motion

detection or each new switching command.

As they are wirelessly networked with actuators and the server, motion detectors can make full use of their advantages and thus be used in a versatile manner in eNet installations. Here are some examples:

Creating groups of lights

If they contain their very own switching actuator, eNet motion detectors can directly and locally control lights and also add more lights to a shared group of lights using the networking function. This allows you, for example, to create a pleasant lighting mood using outside lights at the front door, along the garden path and at the car port, and you can even choose to switch

these lights separately using the networking function.

Creating a comprehensive monitoring zone

Several eNet motion detectors that monitor just one building front can be combined to create a comprehensive monitoring zone, by connecting all the motion detectors to one or more eNet light actuators. This creates an area around the building in which the lights are activated automatically when someone approaches.

Automation with motion and brightness information in the eNet SMART HOME

An eNet motion detector can transmit information about the ambient brightness in its instal-

lation location and about human presence in its monitoring field to an eNet server. This information can be used for an extremely wide range of applications with the help of the automation functions in the eNet SMART HOME app, e.g. with If-Then rules. Here are some examples:

- If the outside motion detector reports a brightness value below 80 lux, the path lighting is switched on automatically. No motion needs to be detected for this to happen. A timing function can then be used to switch the lighting off again at 11 pm. The eNet motion detector can also be connected to an eNet actuator, which is switched on for

3 minutes when motion is detected in the dark.

- If the owner would like to be informed of someone entering their premises at an early stage, during the daytime they can set a light inside the house to briefly flash if motion is detected. All you need for this is an If-Then rule and an eNet switching/push-button actuator that is configured for flashing operation.

eNet motion detectors with sentinel or presence detector functions

Motion detectors are sorted into two typical application fields on the market and, as a consequence, also have different technical designs:

Sentinels are motion detectors that are used on stairs, in hallways and on paths, for example. Here, their job is to detect moving people – i.e. fairly dynamic movements – as quickly as possible and to switch on the light to prevent hazardous situations on the stairs in the dark. You do not need to be able to switch off the light manually in this application. Here, the desired run-on time always elapses and the light switches off if the run-on time is not restarted by more motion being detected.

Distribution of functions between the motion detector and the actuator

Motion detector:

- Brightness measurement
- Motion detection
- Switch-on brightness setting
- Run-on time setting
- Sensitivity setting
- Test functions
- Operating mode setting



Actuator:

- Run-on time management
- Parameters, e.g.:
 - Manual run-on time switch-off
 - Switch-off pre-warning



Comprehensive monitoring zone made up of four eNet motion detectors

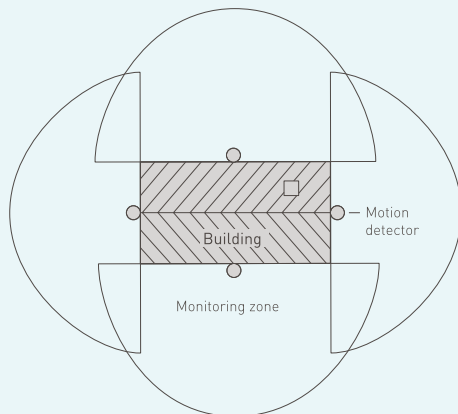

In contrast, presence detectors are motion detectors that are typically positioned in rooms – above workstations in kitchens and offices, above the dining table, or above toilet cubicles. Their job is to also reliably detect people who are sitting down and are only making small movements. The main aim of the presence detector in these situations is to save energy and to switch off or dim the lights if there is nobody in the room anymore. In this application, it must also be possible to switch the light off manually for the purpose of holding slideshows or candlelit celebrations, for example.

In the eNet system, the motion detector functionality is divided between the sensor and the actuator.

The eNet actuators also connected to an eNet motion detector should thus also be configured with the eNet server during the commissioning process, to ensure that the precise switching behaviour desired is set.

In eNet actuators, the “Manual run-on time switch-off” parameter is set to “Off” at the factory, which corresponds to a sentinel function when combined with a connected motion detector.

In eNet SMART HOME installations, this parameter is automatically set to “On” when an actuator is added to the project, and the motion detector automatically adopts the switching behaviour of a presence detector. In this situa-

tion, the connected actuator can be switched off manually at any time using eNet hand-held or wall transmitters, for example. The light also remains switched off if the motion detector continues to detect human presence. Only when no more motion is detected for a period of at least 3 minutes – i.e. when there is nobody in the room anymore – do the actuator and the motion detector resume their normal functions, and the light switches back on again when motion is detected.

Automatic staircase lighting with an eNet wall transmitter

Staircase lighting is a typical application for sentinels. In addition to an eNet motion detector in the front door area, an eNet wall trans-

mitter which can be used to re-trigger the run-on time is installed on each floor. Motion detectors and wall transmitters are connected to the eNet actuator that controls the staircase lighting.

For this application, the “Manual run-on time switch-off” parameter remains “Off” – connected motion detectors are thus interpreted as sentinels in their switching behaviour.

During manual commissioning, when connecting the actuator and motion detector it must be ensured that the run-on time is set on the motion detector first and that it is only connected to the eNet actuator afterwards. This is important because the actuator permanently

Manual run-on time switch-off

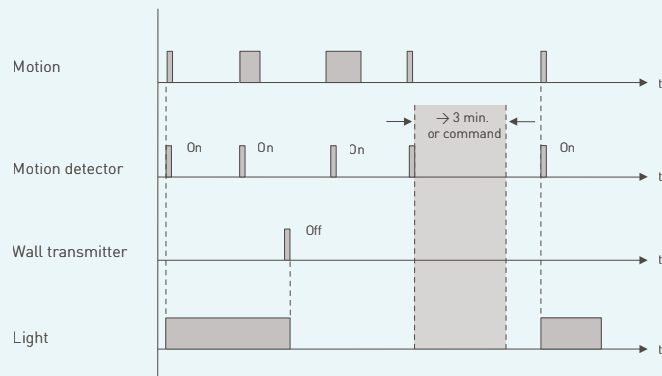

Functional principle – switching staircase lighting

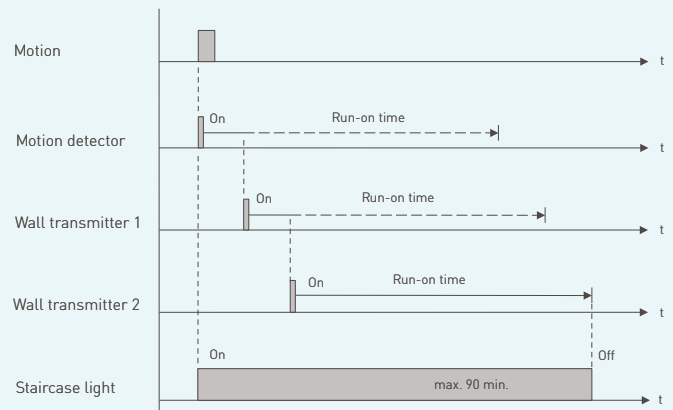

saves the first run-on time transmitted by the motion detector, and continues to use it whenever it is triggered by a connected eNet wall transmitter, for example. Each time a wall transmitter is pressed, it is processed by the staircase lighting actuator as a trigger signal from the motion detector and leads to the staircase lighting being switched on or re-triggered. In this situation, it does not matter which of the two buttons of a connected rocker is pressed. Because the actuator is not allowed to be switched off in Sentinel mode, it reacts to all switching commands equally. This also has the advantage that in the dark, there's no need to press a certain side of the button rocker to switch the light on.

After 90 minutes at the latest, an actuator in Sentinel mode switches back off again – for a brief time at

least – and waits for the connected motion detector to detect motion again.

Activating a pre-warning function

To prevent people from possibly going undetected in unfavourable conditions and being surprised by the lights automatically switching off, the "Switch-off pre-warning" parameter can be set in the actuators in question. This activates a pre-warning function. If the actuators are dimming actuators, this causes the lights to dim softly. If they are switching actuators, this causes the lights to flash briefly before being switched off. In both situations, the people realise that the lights will soon switch off, and can ensure that the actuator is re-triggered using the motion detector or an additionally networked wall transmitter. Potentially unsafe situations in sudden darkness are thus reliably avoided.

Integrating conventional motion detectors

eNet motion detectors are powerful and can be put to highly versatile use. If a building is to be retrofitted with eNet, existing conventional motion detectors can continue to be used. To do this, an eNet universal transmitter must be connected to the existing motion detector's switching output in order to integrate it into the eNet system. eNet actuators are then wirelessly controlled in the building using motion detectors.

Pre-warning function

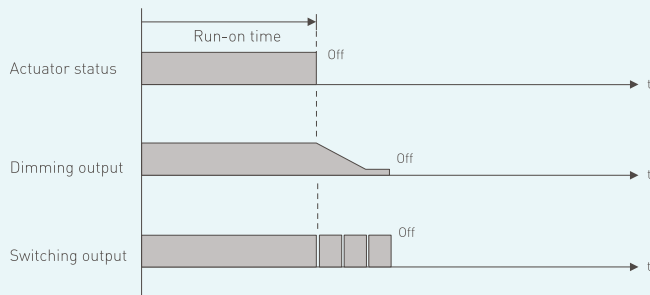

BLINDS, ROLLER SHUTTERS AND AWNINGS

Optimum use can be made of sunlight by automating blinds, roller shutters and awnings. The technology simply adapts to the lighting conditions. If it gets too bright, the slats adjust and dim. If it gets darker, the blinds raise again. That way, users enjoy healthy, natural light and save on electricity too.

1. FUNCTION

Blind actuators control electrical-ly operated slatted blinds, roller shutters, awnings and other shading solutions. Their main job is to supply the motor with power for the desired direction – “upwards” or “downwards”. To prevent damage to the motor, it is impossible to supply both the actuator outputs with power at the same time.

Blind actuators contain two relays and therefore have three switching states:

- No output switched on: The shading solution remains stationary.

- “Upwards” output switched on: The shading solution moves upwards. When the shading solution reaches its end stop, the end stop switch integrated in the motor reacts and interrupts the electricity flow.
- “Downwards” output switched on: The shading solution moves downwards. When the shading solution reaches its end stop, the end stop switch integrated in the motor reacts and interrupts the electricity flow.

All the eNet blind actuators can move the connected shading solutions into defined positions. But for this to happen, the actuators must be adapted to the shading solution’s running times.

2. SHADING SOLUTION POSITIONS

The switching device’s switching state says nothing about the shading solution’s position. So that shading solutions can be reliably moved to a given position – if possible automatically and from any other position – the outputs’ switch-on times are permanently tracked during operation.

End stop and end position

A shading solution’s top and bottom end stop is fixed by the running length. The solution is switched off by the end stop switches, which switch off the drive when the top or bottom end stop is reached – provided that the solution is adjusted correctly. The end stop switches work independently of the switching device. A blind switch can thus remain in the switching position and supply the drive with power even after an end stop has been reached.

The shading solution positions are managed using the switch-on times for moving upwards and downwards. During the commissioning process, the control must therefore save the shading solution’s running time for travelling from the top to the bottom.

SHADING SOLUTION POSITIONS

0%
Top end stop/retracted

100%
Bottom end stop/extended

Shading solution positions

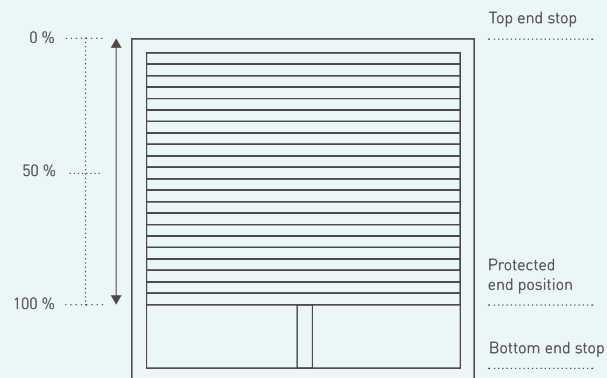

- If the saved travel time is longer than the shading solution's running time, positions from bottom shading solution stops will not be approached correctly.
- If the saved travel time is shorter than the shading solution's running time, the shading solutions will no longer travel to the bottom end stop, because the control switches off beforehand.

A shorter travel time may be useful to protect flowers on the window sill or to leave ventilation slots open. It is not possible to fall short of this position due to other conditions.

Synchronisation with the shading solution running

Due to a shading solution's weight, the running time from the bottom to the top is longer than from the top to the bottom. To compensate for this and to synchronise themselves, the relays only switch off 10 seconds later when moving the shading solution to its top end stop. Timely motor switch-off is guaranteed by the blind motors' end stop switches.

If several shading solutions are moving to the same position (e.g. 30%), they should do so from the same direction to avoid more minor inaccuracies.

It is advisable to use one actuator per motor to control shading solutions of different lengths and widths, or drives from different manufacturers.

3. OPERATING MODES

Slatted blinds –
lighting conditions when the
slats are opened 100% and 0%

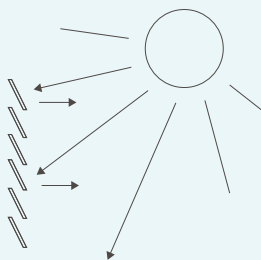

Slat 100% = closed

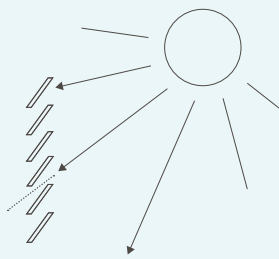

Slat 0% = open

Blinds

Blinds are made up of slats with a controlled angle to the sun. These slatted blinds have a gear unit which, if changing direction, adjusts the slats first of all before actually starting to move.

The slat angle is specified in percentage terms [%], with a value of 0% corresponding to the "open" position – where sunlight can pass through – and a value of 100% corresponding to the "closed" position.

As the travel time and the slat adjustment time are recorded separately, the shading solution can be moved into a specific position and the slat angle can be adjusted afterwards.

Roller shutters

There is no need to adjust the slats in roller shutters. Accordingly, the only parameter is the adjustment of the running time from the top to the bottom end stop.

Skylight

The function of electrically operated skylights differs from the shading solutions described previously in that their resting position is "closed" as opposed to "open". Drives of this type are controlled by reversing, or "inverting" the drive function.

The "Roller shutter" operating mode is selected for window drives. During commissioning, it must be ensured that the fabric tightening and slat adjustment times are not

Roller shutters –
top and bottom end stop

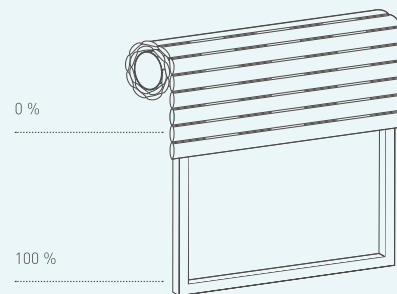

adjusted. Here, too, the actuator extends the running time by 10 seconds when moving the solution into the resting position.

Awnings

So that electrically operated awnings do not sag in the end position, following extension the movement is briefly reversed and the awning is rolled back up slightly so that the fabric is perfectly taut. This function can be taken over by the control for awning drives that are not equipped with this function.

The relevant operating mode – “Blind”, “Roller shutter” or “Awning” – is set with the operating

4. SPECIAL FUNCTIONS

Other functions can be used with suitable accessories. For activation, the devices must be connected to one another and the parameters in the blind actuator must be set accordingly.

Lock-out protection

With the lock-out protection, the user fixes the shading solution in its top end stop and blocks all the automatic functions until the lock-out protection is deactivated.

This protects occupants from any unpleasant surprises – such the

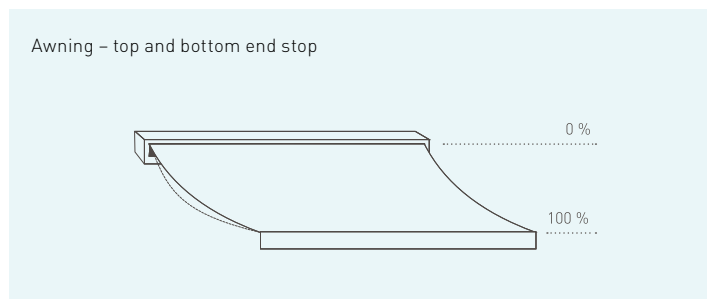

mode switch on the wireless actuator or with the eNet server.

The operating mode switch can also be used to set the shading solution's running time and – depending on the shading solution – the adjustment time for slats or fabric tightening.

roller shutter on the patio door automatically closing while they're in the garden.

Wind alarm

A wind sensor enables shading solutions to be automatically raised depending on the wind strength. The top end position protects sensitive blind slats or awnings from being destroyed by a strong wind or storm.

Sun protection

A brightness sensor can be used to automatically move the shading solutions into a sun protection position, e.g. for plants in the flower box or to screen off office workstations.

Twilight function

The twilight function automatically lowers the blinds to provide privacy when it starts to get dark.

5. BLIND BUTTON

The eNet blind button controls the blind system's flush-mounted inserts. The flush-mounted inserts thus function as a complete eNet blind actuator. The blind button contains the receiver module, which receives the commands from eNet transmitters and transmits them to the flush-mounted insert.

Device setup:

1. Flush-mounted insert for blind system
2. Cover frame
3. eNet blind button
4. Status LED

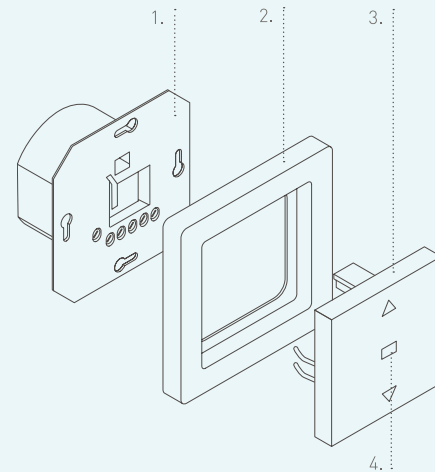

The auxiliary unit technology from the blind system is also supported so that on-site operation via an auxiliary unit, wired groups, the central control (insert for the blind system or mechanical blind switch), wireless transmitters and also the eNet server is possible.

With the help of a wind sensor, a blind's auxiliary unit input can also be used to open a blind or retract an awning in case of a storm. At the same time, the "ON" signal switched by the wind sensor activates a lock function at the auxiliary unit input. This high-priority lock function prevents the blind from being lowered during the storm – overriding the time controller, the app and manual operation.

6. BLIND CONTROL HIERARCHIES

A high-priority command remains active until it is cancelled by the same or a higher hierarchy level. Lower-priority commands are blocked during this time and commands that were not executed previously are not subsequently executed once a higher-level control is cancelled. The device behaviour at the end of a higher-level command is adjustable – depending on the actuator type.

Priorities – control hierarchies

1. (Highest)	Operating mode switch
2.	Lock-out protection As long as the lock-out protection is active, no lower-priority commands are executed.
3.	Restraint As long as the restraint is active, no lower-priority commands are executed.
4.	Wind alarm As long as the wind alarm is active, no lower-priority commands are executed.
5.	Local operation E.g. with the blind button. Following local operation, incoming lower-priority commands are then executed.
6.	Local automatic system
7.	Commands received wirelessly.
8. (Lowest)	Scene

HEATING

Heating is a basic function in buildings and an important factor in order to ensure a comfortable indoor climate at all times. The aim is to make the best possible use of the heat energy used, as this saves money. The most common heating systems today are radiators (radiators) and underfloor heating (surface heating).

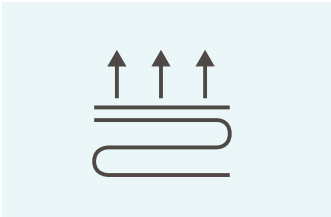

Underfloor heating

The most common form of underfloor heating is heating rooms by pipes laid in the floor, which are heated with water or electricity. The regulation of underfloor heating is either room by room via wall thermostats or via a central thermostat for the entire house. A smart heating control can be done either by replacing conventional wall thermostats or by controlling the central heating system itself if it is not a multi-household installation.

Heating with radiators

Radiators are usually supplied with warm water via a main heating system (boiler). A thermostat head mounted on the radiator directly controls the room temperature using a valve which limits the



flow. Replacing a thermostat with an electronic variant is simple and requires no direct changes to the heating system's water circuit or electrical installation. A smart radiator thermostat runs on batteries

and uses integrated temperature sensors to control the room temperature according to schedules or even the presence of the people in the room.

Heating with eNet SMART HOME



In order to control a heating system with eNet SMART HOME, an eNet server and an installed tado° Professional smart heating system control are required. The tado° system can intelligently control a heating system directly via the boiler, via wall-mounted thermostats for underfloor heating systems or via radiator thermostats. The tado° Professional heating system control is 95 % compatible with all heating systems. Visit www.tado.com for more information on the compatibility of specific heating systems with the tado° system and to find out which tado° components are needed.

Commissioning

The tado° system and eNet SMART HOME are connected in the eNet SMART HOME app. The prerequisite for this is that both the tado° system and the eNet system must be commissioned. Everything is simple after this point. The tado° partner system is added in the eNet SMART HOME app, and the tado° zones are integrated in the eNet building structure. In a final step it is possible to specify a termination condition which determines when the system is to switch from "manual" or "frost protection" mode back to automatic operation.

Functionality

It is possible to set the temperature for the heating system right at the device at any time using the tado° thermostats. In addition, the system can be operated and configured via the tado° app (available for Android, iOS and Microsoft Windows). After connection of tado° with eNet, the eNet SMART HOME app also offers many functions which can be used to control the heating system and can be integrated in further eNet functions. This is possible for the building as a whole, for individual areas (e.g. ground floor) or for individual rooms.

Manual 	Frost protection 	Automatic 
The "manual" setting allows for the room temperature to be set by hand and for specification of the termination condition which determines when the system switches back to automatic operation.	The "frost protection" setting prevents the heating system from dropping below +5°C, which ensures that it does not freeze. At the same time, the termination condition determines when the system switches back to automatic mode.	The "automatic" setting uses the automatic tado° functions. These include the "smart schedules" set in the tado° app as well as "location-dependent control".

Three control modes are available: "manual", "frost protection" and "automatic". In "automatic" mode the heating system is controlled by means of "smart schedules" (the schedules in the tado° app) and by means of "location-dependent control". The "frost protection" and "manual" modes keep the heating system at a constant temperature for a specific period of time, defined by means of a termination condition. The termination condition describes when the mode is to switch back to automatic operation.

If "location-dependent control" is activated in the tado° app, the states "tado° Home" and "tado° Away" are available as triggers in the if-then rules of the eNet app. When people leave the "home zone", these rules can be used to turn

down the heating, lower the blinds or switch off the lights in the house all at the same time. As soon as people return to the "home zone", it is possible to automatically switch on the outside lights or open the drapes, for example.

The automatic tado° functions "smart schedules" and "location-dependent control"

In the tado° app it is possible to use so-called "smart schedules" to define intelligent schedules for every zone and every day of the week so that every room is just the right temperature all the time. In order to ensure that there are no conflicting double schedules, it is not possible to add further heating system control actions in the eNet SMART HOME app. This is also on account of the fact that the "smart

tado° termination conditions

(Valid for the "manual" and "frost protection" operating modes):

For the period of ...	Until next automation	Until ended by user
After a specified period of time, the heating system control switches back to automatic mode.	When the next "smart schedule" time block starts or the next state of the "location-dependent control" changes (come/go), the heating system control switches back to automatic mode.	The operating mode is not ended until a user sets a different operating mode.

schedules" enable activation of the control before the defined switching time so that the desired room temperature is already reached by that point in time. This function is called "early start" in the tado° app. Early action can be taken on the basis of weather forecasts and building characteristics can be considered directly only by means of the tado° schedules.

In the case of "location-dependent control", the tado° app uses the location of the smartphones of the users who have consented to this function and determines on this basis whether the users are at home or not. The states "tado° Home" and "tado° Away" aren't just used for heating system control, but can also be used for other functions via if-then rules.

The functions "smart schedules" and "location-dependent control" can only be configured in the tado° app.

WIRELESS TRANSMITTERS

During operation, wireless transmitters transmit wireless commands that are received from receivers (actuators), evaluated and converted into actions. In this regard, a wireless transmitter can control a single actuator or whole groups of actuators.

1. HAND-HELD TRANSMITTERS AND WALL TRANSMITTERS

Hand-held transmitters and wall transmitters are battery-operated devices with operating buttons or operating rockers. They can be used universally for switching, pressing, dimming and blind control operations, as well as to call up scenes, etc.

Hand-held transmitters

Buttons next to one another are combined to form a rocker. These rocker functions are either used to control individual functions or for scene functions. They are set to individual or scene functions during the commissioning process.

The hand-held transmitters have a two-coloured LED and, during op-

eration, display the transmission status – and thus the success of the operating procedure – followed by the actuator status for 3 seconds.

In eNet systems without a server or app, the 24-gang hand-held transmitter display offers a convenient menu structure and status display with plain text.

Wall transmitters

Wall transmitters are permanently installed in the building and blend harmoniously into the electrical installation. Flat designs also enable installation on furniture, glass panels or other partition walls.

eNet wall transmitters mainly differ from one another in terms of their design and number of indicator LEDs.

Operation

Buttons and rockers are usually assigned fixed functions. The left button on a hand-held transmitter's rocker is used to switch things on, make lights brighter or raise shading solutions. The right button, meanwhile, switches things off, dims lights or lowers shading solutions.

When a rocker is pressed, a sensor sends information indicating

- "Rocker x Up pressed",
- "Rocker x Down pressed", or
- "Rocker x complete surface pressed"

So that several dimming or blind actuators operated at the same time work synchronously, the transmitter also transmits the pressing duration.

2. STATUS MESSAGES

eNet hand-held and wall transmitters display both the actuator status and the transmission status. The actuator status (green LED) indicates the current switching state of the connected actuators, while the transmission status (red LED) indicates whether the wireless telegram was transmitted successfully.

Actuator status

Green status LEDs indicate the status of the connected actuator outputs. To save the battery, the status

is only displayed for a limited period of time following operation.

If more than one receiver is operated by one transmitter, the transmitters combine the messages from all the connected actuators to create a shared total status.

In this situation, status messages from the actuators sending feedback are collected and compared. As long as at least one light actuator reports its status as "switched on" for example, the total status retains the "switched on" value – until finally all the light actuators sending feedback deliver the value "switched off".

Switching and dimming:

- LED green: At least one actuator is switched on
- LED off: All actuators are switched off

Moving the blind:

- LED green: At least one shading solution is outside the resting position (>0%, shading solution fully or partly extended)
- LED off: All the shading solutions are in the resting position (0%, shading solutions retracted)

Illustration of successful/unsuccessful transmission and actuator status

Transmission successful, at least one actuator switched on or one shading solution not in the resting position (>0 %, shading solution fully or partly extended)

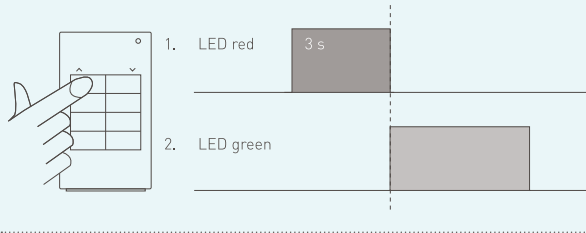

Transmission successful, all actuators switched off or all shading solutions are in the resting position (0 %, shading solutions retracted)

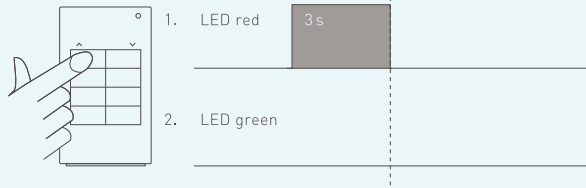

Transmission unsuccessful

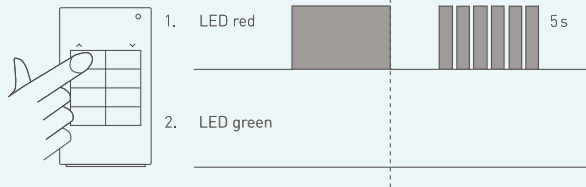

Querying the actuator status

The user can query the actuator status even during operation. Typically, for this purpose, complete surface of the desired transmitter rocker is pressed for between 1 and 4 seconds.

Status feedback from several actuators is displayed as a total status here too. The transmitter indicates the absence of an expected status message as a transmission error.

Transmission status

During and after a rocker is pressed, the status LED indicates an ongoing wireless transmission.

Once the transmission is complete, the red LED goes out if the transmission was successful.

The transmitter indicates a faulty transmission by causing the red LED to flash quickly for 5 seconds after the rocker has stopped being pressed.

Suppressing transmission errors

So that absent feedback does not lead to a transmission error being displayed permanently, it is possible to ignore these "errors".

Situations such as this are caused by changes in the system, e.g. if an installation area has to be temporarily activated due to structural changes, or if an adapter plug for a

switching actuator is pulled out of the socket.

The "Prog" button of the transmitter in question is pressed briefly while the transmission error is being signalled for this purpose. Thereafter, the absent feedback is no longer included in the display.

This exclusion from the total status is automatically reversed as soon as the transmitter receives another status message from the affected actuator.

Battery status

"Battery low"

eNet hand-held transmitters and wall transmitters have been deliberately designed to consume as little electricity as possible.

The power consumption of a wireless transmitter is determined by the wireless transmitter and re-

"Battery low" battery status

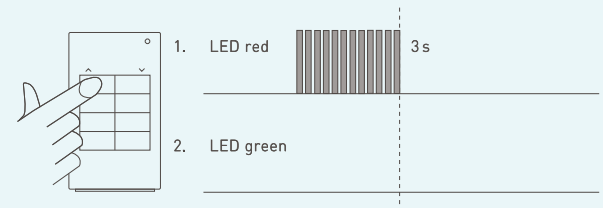

ceiver electronics and available status LEDs, which are not, therefore, used for permanent display. The communication electronics themselves are optimised for minimal energy consumption. The defining factor for the battery life is the transmission frequency.

Because of this, wireless transmitters' battery change cycles cannot be precisely determined, and vary between approximately two and ten years. To prevent users from changing the battery as a precaution, wireless transmitters indicate when a battery is flat. Following an actuation, the status LED flashes slowly for 3 seconds. Querying of the actuator status is omitted. In addition, the wireless transmitters transmit information about their battery's status in their telegrams.

3. UNIVERSAL TRANSMITTERS

Binary inputs record binary electrical input signals – i.e. power supply switched on, power supply switched off. The recognised input events are converted into wireless commands.

The eNet universal transmitter integrates devices with a 230 V switching output into an eNet system. These devices may be devices with a touch function, which revert to the resting position immediately

after being pressed, or devices with a switching function, which have two stable switching positions. The universal transmitter gets its supply voltage from the 230 V mains, so that battery-independent operation is possible.

The universal transmitter has two binary inputs. It detects switch-on and switch-off edges on the input terminals, and transmits commands to the connected actuators. Users can choose whether to operate the two inputs as individual functional channels (two functional channels with one-surface operation) or whether to combine them to create a shared functional channel (one functional channel with two-surface operation).

Depending on the operating mode set, the universal transmitter transmits commands relating to:

- switching lights or other consumers;
- dimming lights;
- activating a doorbell;
- opening and closing blinds;
- retrieving or saving scenes.

The "Scenes for signal contact" operating mode can also be activated using the eNet server. This mode can be used to implement a wind alarm for blind systems using a wind sensor, for example.

The universal transmitter can therefore be put to highly versatile use.

230 V universal transmitter

Input circuit with switching contacts, e.g. two switches, motion detectors, timers, etc.

Operating mode:

- 2-K-⊖, 2-gang automatic functions

Function:

- Close contact: On
- Open contact: Off

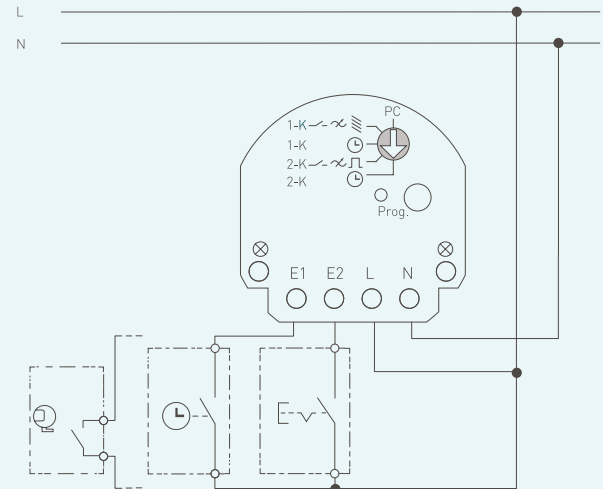

SCENES AND SPECIAL FUNCTIONS

Scenes enable the user to save certain electrical installation default settings and call them back up at the touch of a button for different situations – in a room, for example.

Example: Calling up the “Watch TV” scene causes the blinds to move into a certain position, the ceiling lights to switch off, the wall lights to dim to a defined value, the screen to descend and the projector to switch on.

Depending on whether the system includes an eNet server, the functional concepts for scenes differ from one another:

- SMART HOME scenes use the eNet server to enable especially convenient and flexible operation via operating stations and via mobile end devices such as smartphones. It is also possible to operate the tado° Professional heating system control via SMART HOME scenes.
- Manual scenes can be easily and functionally called up and saved from every operating station in the system.

Scenes ...	Smart home scenes	Manual scenes
Calling up	<ul style="list-style-type: none"> – Hand-held/wall transmitters – eNet SMART HOME app – Automatically using rules or time schedules 	Hand-held/wall transmitters
Creating	eNet SMART HOME app	Hand-held/wall transmitters
Changing	eNet SMART HOME app	Hand-held/wall transmitters
Linking to conditions	eNet SMART HOME app	–
Status message	eNet SMART HOME app	Hand-held/wall transmitters
Everything on/off Everything up/down	eNet SMART HOME app	Hand-held/wall transmitters
Configuring threshold functions	eNet SMART HOME connect	Only with sun/twilight sensor
Configuring blocking functions	eNet SMART HOME connect	Lock-out protection and restraint – only with hand-held transmitter display

1. TECHNICAL BACKGROUND

The technical concept behind the scene function is that actuator states are not transmitted as (switching, dimming or blind) commands. Instead, the situations for the various scenes are saved in the receiving actuators. When calling up a scene, the actuators receive a scene number and set the state that they have saved under this number (i.e. the desired switching state, brightness value or a shading solution position).

That way, a certain scene can also be called up by several transmitters if they transmit the same scene number.

The number of scenes available in the eNet system depends on whether or not there is an eNet server in the system.

eNet scenes	With no eNet server	With an eNet server
Individual scenes	16	34
Everything on/ everything up	1	For building, area and room respectively
Everything off/ everything down	1	For building, area and room respectively

2. SMART HOME SCENES

The flexible smart home scenes, which can be called up using hand-held/wall transmitters and using mobile devices, are used in an eNet system with an eNet server. These scenes are conveniently configured in the eNet SMART HOME app. Here, new scenes can be quickly created, while existing ones can be modified or deleted in a flash. In addition to being allocated to a meaningful icon, each scene is assigned to the actuators to be controlled by means of calling up scenes. A scene can be created very quickly if the desired room situation is set manually beforehand and a scene is then adopted in the app in a single step.

So that scenes can be directly triggered using the buttons on hand-held or wall transmitters, the installation engineer configures the relevant buttons in the commissioning interface for "app use". The button can then be linked either to a scene or directly to actuators in an If-Then rule.

However, smart home scenes can be used in timing functions in addition to being activated directly. For example, every morning at 7 am a "Good morning scene" can help you wake up in a relaxed way by opening the blinds slightly, softly dimming the lights and preheating the bathroom to 22°C.

Smart home scenes – operation with the eNet SMART HOME app or hand-held/wall transmitters

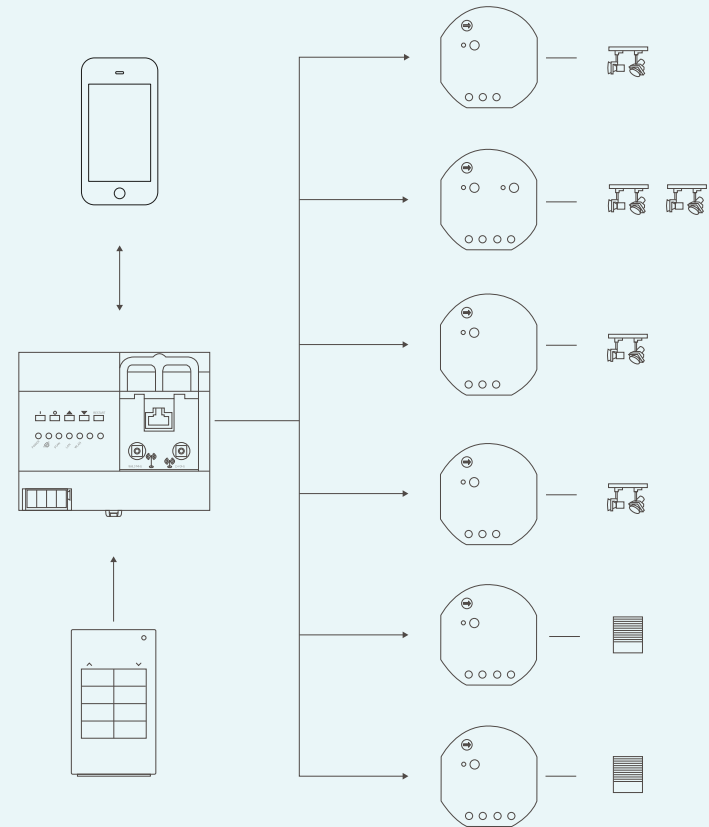

3. MANUAL SCENES

In systems without an eNet server, the scene buttons on a hand-held or wall transmitter are always directly connected to actuators.

Transmitter buttons and actuators are connected during the manual commissioning process.

As with scene changes, actuator values are set directly during oper-

Manual scenes – operation with hand-held or wall transmitters

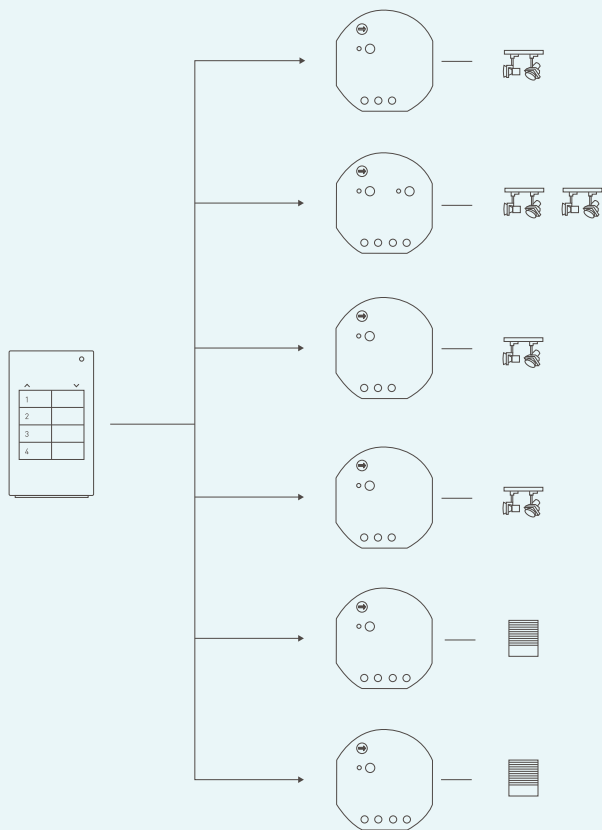

ation, by setting the desired room situation and then saving it by pressing and holding the relevant scene button.

4. “EVERYTHING ON/UP” – “EVERYTHING OFF/DOWN”

Switching and dimming actuators

The “Everything on” and “Everything off” scenes are used for switching and dimming actuators.

The scenes are created automatically when using the eNet server. They can be controlled from the app for the entire building, for the individual areas and for each room respectively. Should certain actuators be excluded by the central control, this can be adjusted for the actuator in question in the “Device configuration” area of the app.

In an eNet system without a server, the central control is configured directly using the hand-held or wall transmitters. Buttons are pre-set with these scenes.

“Everything on” and “Everything off” are automatically created too, as soon as a connection is established between a transmitter and an actuator. The scenes are only deleted if all the connections between the transmitter and actuator are disconnected. During manual commissioning, no excep-

tions can be defined by the central control.

While the “Everything on” and “Everything off” scenes are pre-set with switch-on and switch-off, other values can be saved in the actuators too.

Blind actuators

When centrally operating blinds in the eNet SMART HOME system with the eNet server, the positions that the blinds should move to are defined by the end stops.

In contrast, there are no values for raising or lowering blinds saved in blind actuators during manual commissioning. As is the case with switching actuators, the scene is also created automatically.

The blind position in question must be saved so that a blind actuator commissioned manually responds to the “Everything on” and “Everything off” scene. Let’s imagine that the “Everything off” scene is called up. The blind must then be moved to the desired position (e.g. blind lowered) within the next 3 minutes. The user must then press the “Everything off” button for 4 seconds to save the “Everything off” scene again.

The blind actuator now responds when the “Everything off” button is pressed, causing the blind to lower.

The “Blind down” value now saved

can only be deleted either by resetting to the factory settings or by using the eNet server. A new position can be saved at any time, however.

If a blind actuator receives a scene command without a blind position having been saved beforehand, the actuator outputs switch off.

Heating system control

Centralised control of the heating system is possible via direct operation in the eNet app, via rules or via SMART HOME scenes for individual rooms, individual floors or for the entire system. The mode (automatic, manual, frost protection) and, in manual operation, the duration can be specified.

5. MORE FUNCTIONS

There are more special functions, which are internally based on the scenes' mechanism, in the eNet system. These enable control operations based on thresholds or priorities.

- Threshold functions
 - Sun protection function
 - Twilight function
- Wind alarm
- Lock-out protection
- Restraint

These functions can act on indi-

vidual or multiple actuators. The lock-out protection function can be created locally for the balcony and patio door, for example. The wind alarm applies globally to all the outside blinds in the house.

Threshold functions

The threshold functions are triggered when a limit exceeds or falls below a certain value and call up appropriate actions. Examples of threshold functions include the sun protection function, which causes the roller shutters to move into a sun protection position, or the twilight function, which lowers the roller shutters to provide privacy and switches on the light at the same time.

Threshold functions are created in pairs; in other words, they are made up of two individual scenes. The first one is called up when a value exceeds the set threshold, and the second one is called up when a value falls below the set threshold.

Blocking functions

Blocking functions are also created in pairs and are always connected to a priority that interferes with the "normal" functions. A blocking function is valid until it is cancelled again or another higher-priority command is received. During this time, normal operating functions or scenes are not executed.

If a blocking scene is cancelled, the behaviour during cancellation can be pre-defined. Switching and dimming actuators can switch on or off, and blind actuators can power up or shut down. Alternatively, the state prior to the blocking function can be restored. In other words, if no action is performed in the basic setting, the current state when the blocking function is cancelled is retained.

Examples of blocking scenes include the wind alarm and lock-out protection.

Restraint

The "Restraint" function is also used to implement priority controls. Unlike with individual scenes, the actuator does not access a saved state (target value); instead, the sensor also transmits the desired state.

When a restraint command is received, the actuator adjusts its output according to the received value and blocks its control hierarchy accordingly for other operations.

6. "SCENES FOR SIGNAL CONTACTS" OPERATING MODE

In addition to the "Scenes" operating mode, eNet universal transmitters also have a "Scenes for signal contacts" operating mode. Unlike with eNet hand-held and

wall transmitters, here the input signal is not simply pressing a button or rocker, but rather the closing and opening of an electric signal contact.

Examples of such signal contacts include outputs on electronic timers, motion detectors, wind sensors, leakage sensors, thermostats or window contacts.

When the contact is closed, the eNet transmitter can call up a set threshold or blocking function, which it then resets when the contact is opened again.

Examples: Wind alarm for blinds, blocking function for fan heaters when windows are open, etc.

If this scene is configured for "app use", it is possible to call up one smart home scene in the app when closing the contact, and another one when opening it.

eNet SERVER

The eNet server is the heart of the eNet SMART HOME system. It forms the basis of a smart home and enables operation using the eNet SMART HOME app – from the local network, and via the secured remote access solution, eNet SMART HOME remote.

eNet SMART HOME connect – the integrated, browser-based commissioning interface – is the installation engineer's commissioning tool for the entire system. Partner systems, e.g. the smart

heating system control from tado° Professional, require an eNet server, but are directly connected to the system via the eNet app and not via the commissioning interface.

Creating the building structure for commissioning

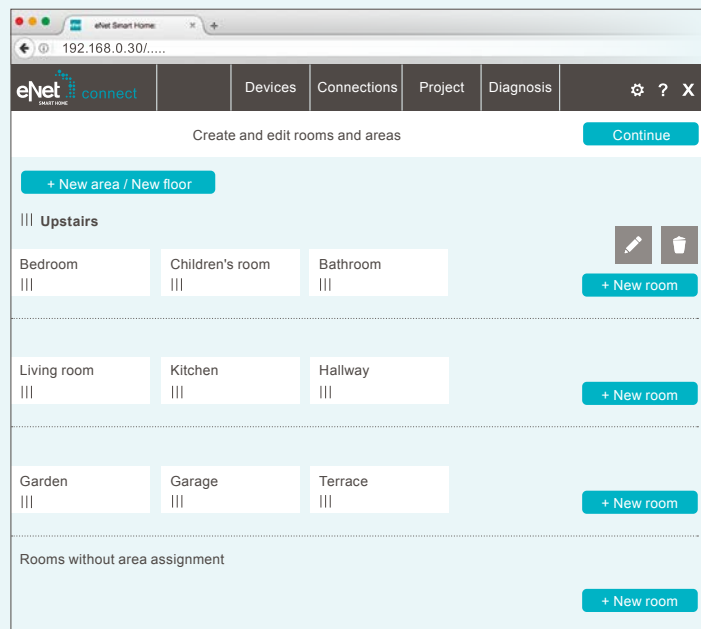

1. eNet SMART HOME connect COMMISSIONING INTERFACE

The eNet system is commissioned using a PC and the eNet server. This is done using eNet SMART HOME connect, the browser-based software application, which is already included in the eNet server.

Once the PC and the eNet server have been connected to one another, the application can be started. To do this, either "enetserver" or the IP address must be entered into the web browser. The eNet SMART HOME app can also be used to determine the IP address. No additional software is required.

The PC is either connected using a network cable or wirelessly via WLAN.

The next step is commissioning. A project and a building structure must first be created for this purpose. Then, devices are added to the project, either by performing a device search or manually. These devices are given unique names depending on their application and are functionally connected to one another.

Finally, the configuration is wirelessly loaded into the devices. System documentation can be automatically created as a PDF document for the system handover to the customer. This documentation contains all the details of the system in a clearly arranged format, so that future expansions or changes in use can be easily implemented.

Connecting a wall transmitter to two different dimming actuators

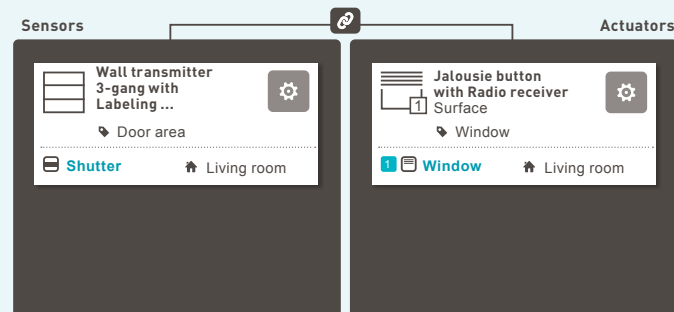

eNet server functions for the ...

Installation engineer

Customer

- | | |
|--|---|
| <ul style="list-style-type: none"> • Creating the building structure • Device search for adding devices • Localising devices for the purpose of unique identification • Resetting the device to factory settings • Configuring the device • Automatically creating project documentation • Creating project back-up • Activating eNet secure • Creating and programming connections between devices • Measuring signal quality to diagnose errors • Recording telegrams to diagnose errors • Updating the device and server software | <ul style="list-style-type: none"> • Operating and visualising the system via the eNet SMART HOME app • Secure remote access via the app and eNet SMART HOME remote • Adding partner systems, e.g. tado° heating system control • If-Then rules: Logical links between system functions • Smart home scenes: Switching device groups using the app or hand-held/wall transmitters • Timing: Automatic device control, with Astro function as an option • Providing measurement data such as energy consumption • Load management • Displaying actuator statuses via the eNet SMART HOME app • Fully encrypted wireless transmission • Operation via voice control (Alexa / Google) |
|--|---|

2. OPERATION AND AUTOMATION USING THE eNet SMART HOME app

The eNet SMART HOME app allows for easy and convenient control of the eNet Smart Home system via smartphones or tablets. Up to eight devices can be logged onto the eNet server at the same time.

With the app, it is possible to access the smart home from a local network or even via the remote access solution over the internet. To do this, the remote access solution, eNet SMART HOME remote, must simply be set up for the users in question.

The app also offers the opportunity to quickly configure the eNet system – by creating scenes, timing functions or If-Then rules, for example.

The most important device and scene access features can be saved as favourites on the app's homepage, so they can be called up at the mere tap of a finger.

Where can you get the eNet SMART HOME app?

The app can be downloaded for iOS from the iTunes App Store and for Android from the Google Play Store.

System requirements for smartphones

For installation of the eNet SMART HOME app, a smartphone with the iOS operating system (version 10 or higher) or the Android operating system (version 5.0 or higher) is required.

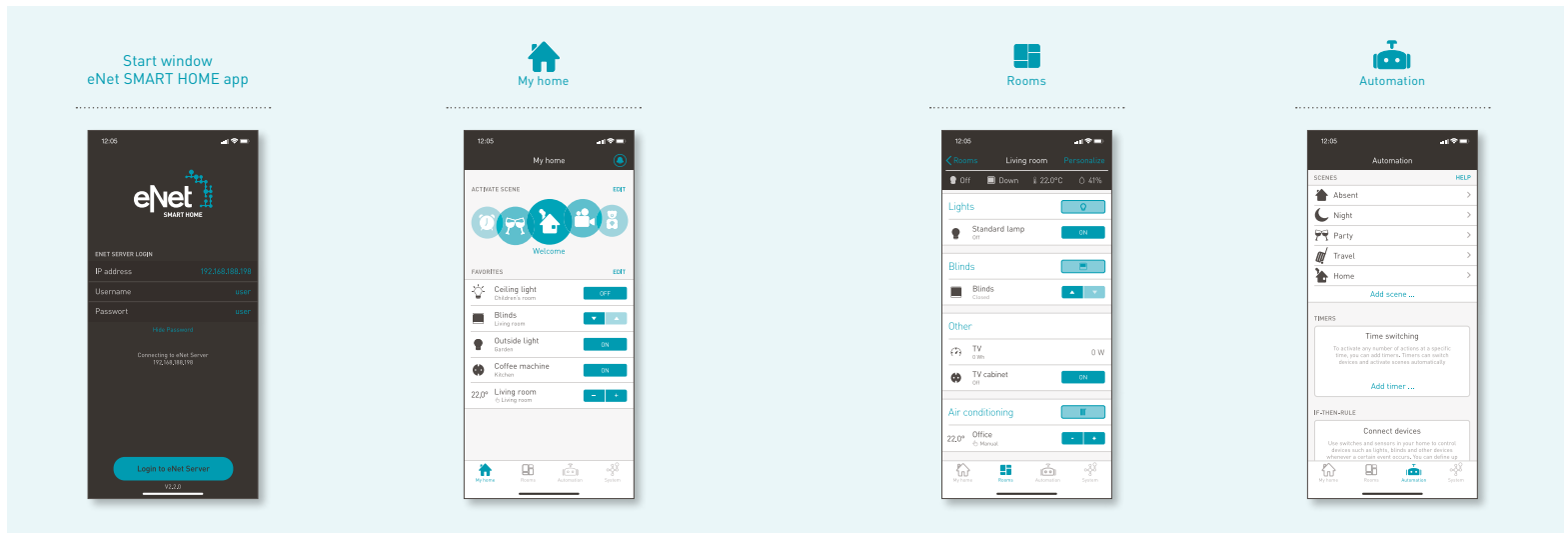

Starting up the app in just a few steps:

1. Connect the eNet server to a WLAN router via LAN or WLAN.
2. Install the eNet SMART HOME app from the App Store on your smartphone.
3. Connect your smartphone to the WLAN router.
4. Call up the app and connect to the eNet server.
5. Enter the username and password.
Default setting for app users: "user".

Default setting for the administrator: "admin".

For security reasons, the passwords for these accounts must be changed by the installation engineer/customer during commissioning.

6. Select "Log onto the eNet server".

Determining the eNet server's IP address with the app

The eNet server's IP address can be found on the app's homepage and in its system menu.

The functions of the app's various views

The **My Home** view enables the following actions:

- Directly calling up scenes as favourites
- Operating eNet devices as favourites
- Reading information about incidents, e.g. if an eNet device's battery is flat

The **Rooms** view enables the following actions:

- Operating eNet devices

The devices in the eNet system can be operated individually or together using central functions via the app.

- Recording the devices' statuses at a glance
- Reading off the connected devices' current output and consumed energy using eNet energy sensors
- Changing the order in which the lights, blinds, climate control and other devices in a room are operated.

- Making device settings

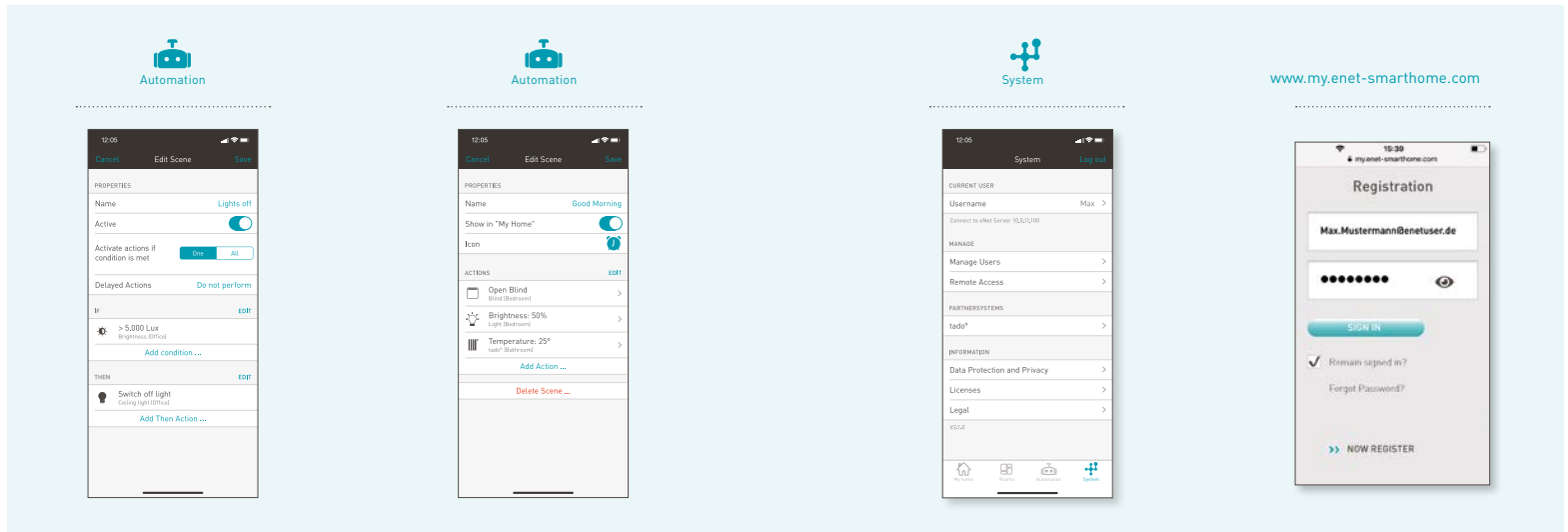

The **Automation** view enables the following actions:

- Creating scenes

Defined states for devices, lights and blinds can be saved as a scene in the app. The current room situation, for example, can be easily saved as a scene. Various wireless functions can also be connected to one another to form scenes.

- Creating If-Then rules

Events on hand-held/wall transmitters and sensors can be used to e.g. trigger smart home scenes, to activate timing functions, etc., using logical rules.

Example: If the tado° presence detector outputs a trigger that everyone has left the building (AWAY state), then it is possible to activate the actions "Switch off light" and "Lower blinds".

- Creating timing functions

Using timing functions, actions can be automatically performed at a certain time. Devices can be switched, scenes can be executed and even If-Then rules can be activated or deactivated.

Blinds, for example, can be raised or lowered in a time-controlled manner when the sun rises and sets, thanks to the Astro function.

The **System** view enables the following actions:

- Creating and managing new users; this is where passwords and user rights are assigned.
- Commissioning and setting up partner systems
- Setting up remote access for app users
- Logging off app users from the linked server (the favourites are deleted here)

Remote operation

With eNet **SMART HOME remote**, the remote access solution, users can operate eNet devices via the app and the internet while they're on the move after completing a simple activation process.

Setting up remote access:

1. Sign up on my.enet-smarthome.com and create a user account.
2. Connect the app in the home network to the eNet server, and enter the user data from my.enet-smarthome.com in the app to activate remote access.

3. ASSEMBLY AND NETWORK CONNECTION

The eNet server is designed to be installed in the distributor. It can also be used on a mobile device for commissioning on the construction site, in the workshop or at the desk – using the enclosed plug-in power supply unit.

For communication with eNet actuators and transmitters, the eNet server has an internal antenna and a bus line connection for wired communication with eNet DRA components.

Connection via a router to a local network can take place either using a wired network connection

(LAN) or via the integrated WLAN module and the internal WLAN antenna – the choice is yours.

Connections for an external eNet and an external WLAN antenna ensure operation in sub-distributors with metallic casings. These antennae are positioned outside the distributor.

A wired network connection (LAN) via a router is provided for commissioning the eNet server for the first time; the server is assigned an IP address automatically via DHCP during this process.

It is also advisable to use a network cable for normal operation once commissioning is complete, so as not to be affected by any faults in the WLAN network. Alternatively, the eNet server can be connected to a router via WLAN. Once the network name (SSID) and the network key have been entered, the eNet server connects to the local WLAN network as a client.

4. DATA SECURITY

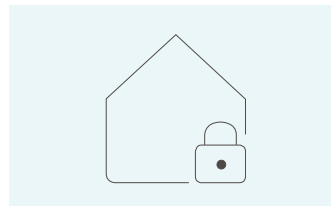

A smart home offers many advantages. Intelligent building technology enables convenience, security and improved energy efficiency both at home and at work. Networking throughout the home automates processes. An extremely wide range of devices and functions can be integrated and adapted to individual requirements.

Due to extensive networking and individual adaptation to user behaviour, personal data protection and technical data security are particularly important issues that have to be dealt with appropriately. This applies to all the network

devices and servers used in a smart home.

Networked devices can constantly exchange signals and data. This traffic must be protected against unauthorised viewing and access. Sensitive and personal data – like the number of occupants, the times they are at home and away, and user behaviour, for example – becomes an issue as soon as a network is set up within or around a building. The system itself, as well as the login data, must also be protected against unauthorised access and manipulation.

5. eNet SMART HOME secure

eNet SMART HOME protects the system with a complete package of measures.

Encryption

All wireless traffic between devices in the eNet SMART HOME system is encrypted. This is true for both data traffic in the local network and controlling via the remote access solution.

This prevents interception of transmitted data.

Server location

All internet services are carried out exclusively through servers based in Germany.

View of the eNet server

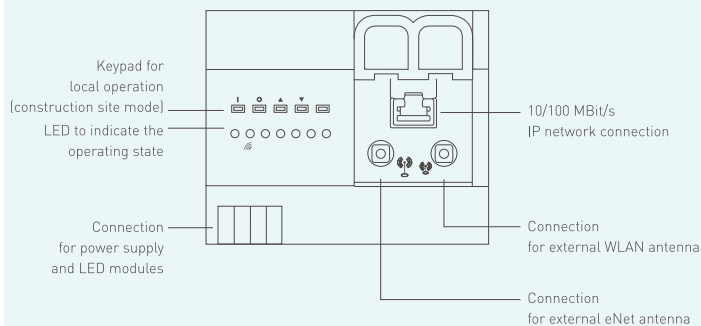

Protection against tampering

eNet systems are protected against tampering once all the protective measures have been commissioned and activated.

The programming function on the devices themselves (the Prog button) can also be blocked for this purpose, so that changes to the devices can only be made by authorised users using the password-protected commissioning interface. The eNet SMART HOME app, the project export file and remote access are all password-protected too.

eNet SMART HOME is constantly evolving. If security breaches are identified later on despite all the precautions, they can also be rectified following installation during ongoing operation by means of updating the software in the eNet server and in the eNet products.

Individual device keys

Individual device keys, which are neither visible to installation engineers nor to users, are used for communication purposes.

The eNet Security Cloud Service provides the required keys, so there's absolutely no need to enter keys manually or scan them using a QR code, for example.

6. ENCRYPTED REMOTE ACCESS – eNet SMART HOME remote

eNet SMART HOME allows the user to access their eNet system, even when they're not at home. And for this remote access, they use the eNet SMART HOME app in the exact same way they would do if they were there in person.

Two steps are necessary to use the remote access solution:

- A user signs up to my.enet-smarthome.com once.

All users of the eNet system can activate remote access on their smartphone with this user data.

- The user data is entered in the app while the user is in the home network and the app is connected to the eNet server.

This information only needs to be entered once on every smartphone the user would like to use for remote access.

Once these steps are complete, remote access is available instantly if the eNet SMART HOME app is being used outside of the home network and both the smartphone and the eNet server have an internet connection.

This activation process is independent of commissioning by the professional installation engineer and can be carried out directly by the system user at any time.

The installation engineer can also access the system remotely for maintenance purposes, using the eNet SMART HOME connect commissioning interface. To do this however, the user must grant the installation engineer access to the system, and they can withdraw these rights at any time too. The connection via the remote access solution is secure and always encrypted.

7. WLAN ENCRYPTION

On the network and WLAN side, system protection is the responsibility of the system operator. The eNet server supports WPA2 encryption, which is used by standard routers for home networks, for WLAN communication.

8. RECOMMENDATIONS FOR SECURITY

Use contracts to protect your privacy

It may be possible for installation engineers to view personal data while working on the network.



To protect such data, it is advisable to have the installation engineer sign a contract to protect your privacy.

Set up a multi-functional security concept

For comprehensive security, it is not enough for individual security elements to be installed on various components. In the smart home with its networked, interacting devices, implementing a consistent security concept without any gaps is an absolute must.

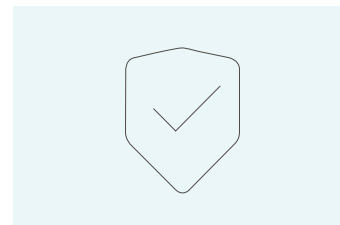

This is because the entire system is only as strong as its weakest link.

Ensure professional installation

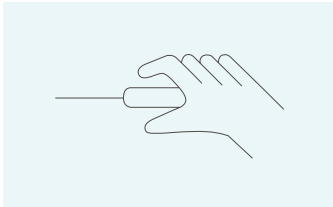

Careful, professional installation is a basic prerequisite for a reliable network in the smart home. And this is precisely why only specialist dealers should be tasked with the work. They can give you specific information on data security and turn a secure smart home into a reality.

Use secure passwords

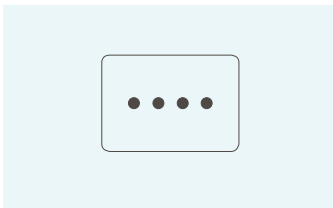

Whether you're on the computer, on your smartphone or in the smart home, strong passwords are vital for data protection. You should never continue using the default passwords set on the devices, but should instead immediately replace them with unique passwords. New passwords should be sufficiently long and also include special characters if possible.

It is also advisable to change passwords on a regular basis for your security.

Protect networks carefully

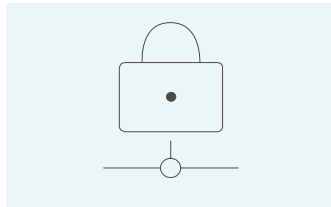

Well-secured networks are protected by a firewall that prevents unauthorised individuals from intercepting data or signals or even from being able to log into the system. A high-quality WLAN router is absolutely indispensable in this regard.

Carry out regular updates

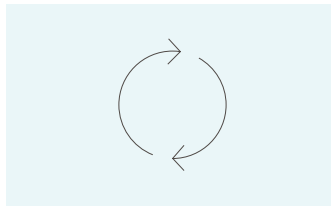

It is important for your security that the technology is always up to date. This is because security requirements can change, and the software on eNet devices is regularly revised and improved to reflect these changes. Performing regular updates of all devices prevents unnecessary security gaps.

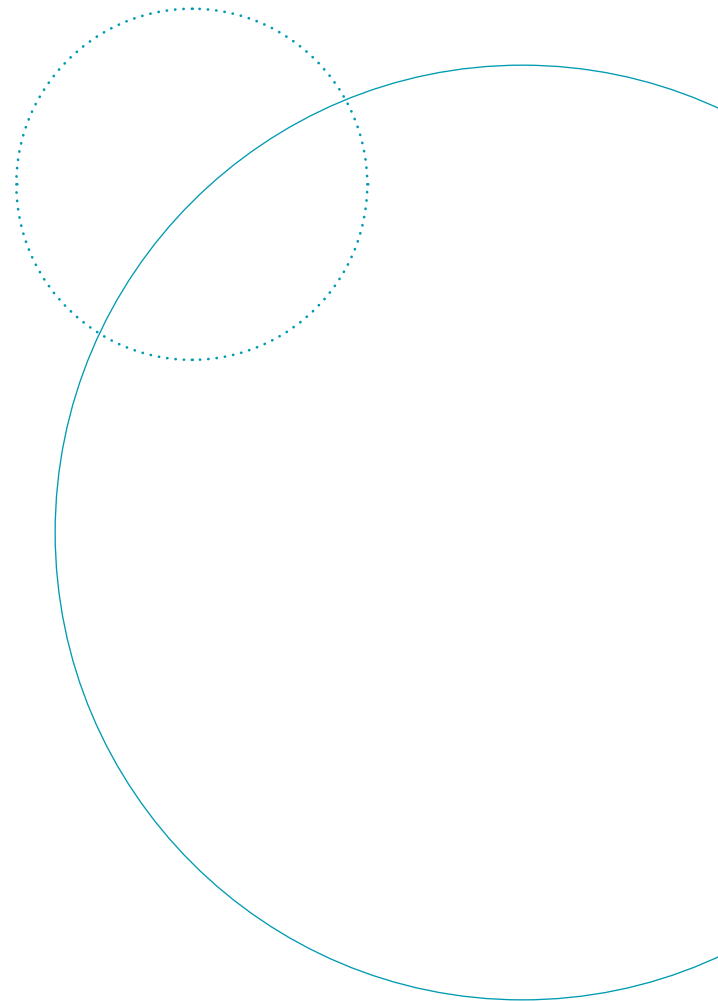

DEVICES FOR INSTALLATION IN DISTRIBUTORS

Electrical distributors are the ideal installation location for electronic switching devices, because a) this is where the power supply lines enter the system, and b) this is where the cables for the final electric circuits collectively exit the system. Main and sub-distributors can be accessed and operated at any time, and can be expertly and conveniently wired by specialist tradesmen.

1. SETUP

Because electrical distributors shield radio waves with their often high metal content (steel doors, DIN rails, neighbouring devices), a modular concept that separates actuator systems and wireless communication from one another was pursued. A DRA installation is therefore made up of application modules, a power supply and a DRA receiver module or the eNet server.

The application modules communicate in the distributor via a wired bus. A maximum of 32 modules

can thus be supplied with power and information. The connection to the wireless networking solution is established via the receiver module or the eNet server.

These two devices not only have an internal antenna, but also a connection for an external antenna too. The latter enables wireless communication for distributors with metallic casings and is installed outside of the control cabinet. For better receiver characteristics, the external antenna (eNet or WLAN) should be placed on a metallic surface.

eNet DRA installation with DRA receiver module

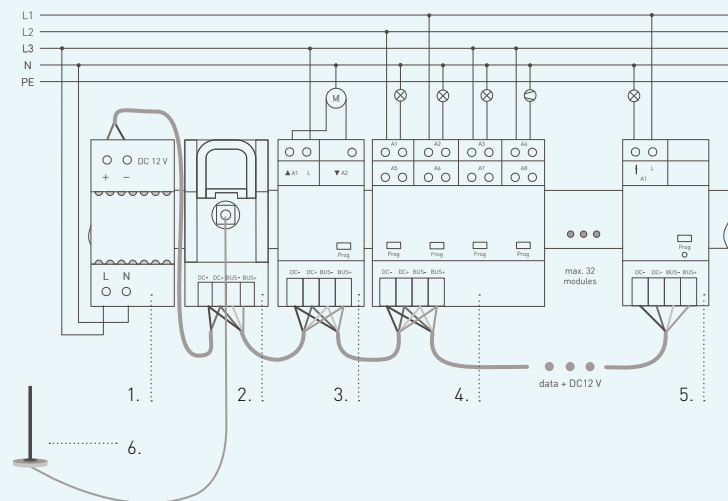

1. 12 V DC / 2 A power supply
2. DRA receiver module
3. Blind actuator, 1-gang DRA
4. Switching/blind actuator, 8/4-gang DRA
5. Switching actuator, 1-gang DRA
6. Additional eNet antenna

The connectible modules provide all standard applications. The modules are networked with transmitters and can be parametrised to suit user requirements.

The application modules therefore contain operating elements such as indicator LEDs, operating buttons and a programming button.

The DRA receiver module or the eNet server are connected to the application modules with a connection cable, e.g. J-Y-(St)-Y 2 x 2 x 0.8 mm. This connection cable can be wired in a line, star or tree shape.

eNet DRA devices need a 12 V power supply to supply the bus function with power.

2. DRA RECEIVER MODULE

The DRA receiver module controls the bidirectional communication between the modules and the eNet wireless system's other components. Except for one LED that indicates operation, the receiver module does not have any operating elements of its own. There is no need to commission the DRA receiver module separately; there are no adjustable parameters.

The receiver module must not be used together with the eNet server within a DRA installation.

3. eNet SERVER AS THE RECEIVER MODULE

The eNet server also has a receiver module function – meaning that application modules can be connected to it too. The eNet server therefore replaces the DRA receiver module in a DRA installation.

It is not possible to operate an eNet server and DRA receiver module on the same bus line at the same time.

DRA receiver module

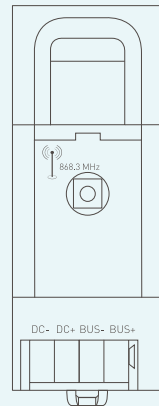

4. DRA APPLICATION MODULES

The application modules not only contain electronics for communicating with the receiver module, but also components for the appropriate application. These components might be sensor or actuator modules with a single- or multiple-channel design.

Each application module also contains the necessary operating elements for its function, such as local operating buttons, status LEDs and operating mode switches.

eNet DRA installation with eNet server

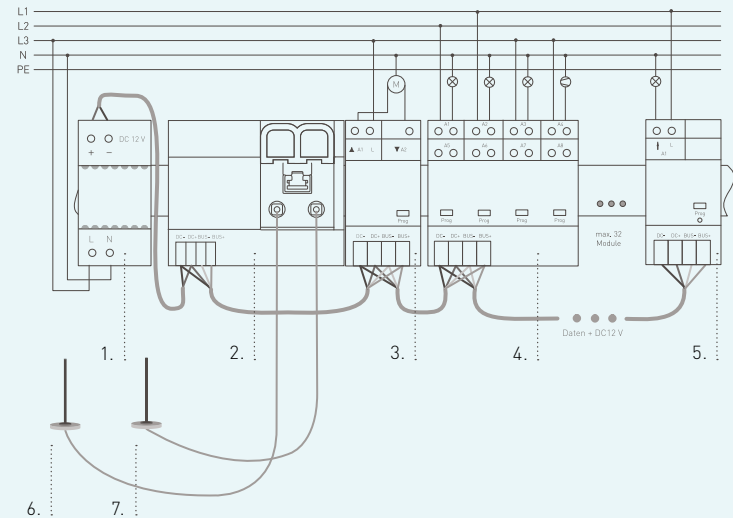

1. 12 V DC / 2 A power supply
2. eNet server
3. Blind actuator, 1-gang DRA
4. Switching/blind actuator, 8/4-gang DRA
5. Switching actuator, 1-gang DRA
6. Additional eNet antenna
7. Additional WLAN antenna

eNet DRA devices provide the same functions as in the other designs. Commissioning either takes place manually or using the eNet server. If commissioning is carried out using the eNet server, parameters can be set, connections to other devices can be established, and functions visualised. Connected modules' device software

can be updated without impairing the other modules' ability to communicate.

SENSORS

Physical sensors record measured values from the immediate surroundings and send measured values or control telegrams to actuators.

1. ENERGY SENSORS

To name but one example, energy sensors measure the power consumption of connected electrical appliances. The data is transmitted to the eNet server either periodically or when configurable thresholds are reached. It is then evaluated on the eNet server and made available to the eNet SMART HOME app for display purposes.

For load management applications, rules which trigger freely selectable actions when values exceed or fall below adjustable limits can be created in the eNet SMART HOME app. An electrical consumer can thus be switched off using a switching actuator, for example.

From a technical standpoint, the eNet energy sensors are identical. The various designs enable measurement in different installation environments.

In the case of consumers that are operated with three-phase alternating current, the 4-gang DRA en-

ergy sensor is used. Socket outlets for permanently installed appliances such as the dishwasher are provided with an upstream 1-gang Mini energy sensor, while an energy sensor in an adapter plug housing is ideal for mobile appliances.

2. SUN/TWILIGHT SENSOR SOLAR

The sun/twilight sensor Solar enables automatic blind and lighting control depending on the sunlight and the temperature in the room.

The sun/twilight sensor Solar is attached to a window pane from the inside. When sun and twilight thresholds are reached, scenes are triggered and the blind position or light brightness, for example, is adjusted to the desired state. Additionally, to provide sun protection, the blind can be automatically lowered when an adjustable temperature threshold is reached, e.g. to protect against overheating in summer.

3. CONVENTIONAL SENSORS WITH A SWITCHING CONTACT

Conventional sensors are not specifically intended for one installation system.

Examples:

- Motion detectors switch the light when they detect movement.
- Wind sensors open the blinds or retract the awnings in case of a storm.
- Timers switch electrical consumers depending on the time.

Devices of this type can be connected to eNet with the help of eNet binary inputs, such as the universal transmitter.

Depending on their configuration, binary inputs can transmit the type of actuation and its duration. As a result, devices are switched, lights dimmed or shading solutions controlled.

Special functions enable priority controls and thus protection against operation outside of certain blocking times or under particular conditions, such as a wind alarm with blocking function.

eNet universal transmitter and wind sensor with 230 V signal contact

- Wiring: Wind sensor with wind sensor interface
- Operating mode: Scenes for signal contact
- Function:
 - Close contact – Call up “wind alarm”
 - Open contact – Reset “wind alarm”

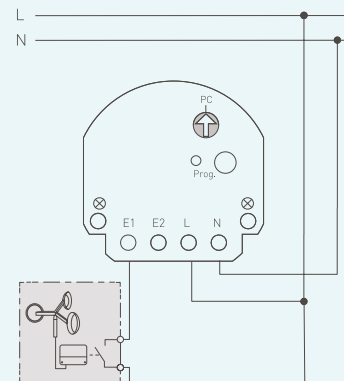

DIGITAL SERVICES

With the support of voice assistants, you can control different things using your voice. It's possible to generate plenty of practical applications by using a code word to activate the assistant and giving simple or complex spoken commands. Your eNet SMART HOME can also be operated and controlled via voice assistants. Amazon Alexa and Google Assistant are amongst the best-known voice assistants on the market and your eNet SMART HOME can be operated and controlled via these two assistants if desired.

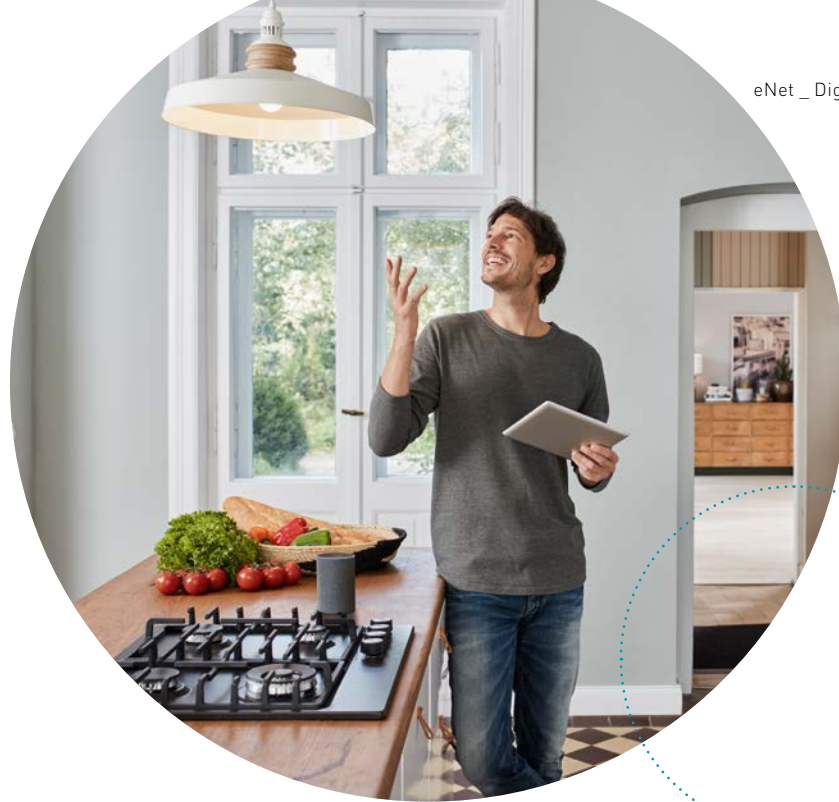

1. VOICE CONTROL VIA AMAZON ALEXA

In order to use the voice assistant Amazon Alexa with eNet SMART HOME, you need an eNet server, the installed eNet SMART HOME app, a My eNet account with activated free-of-charge remote access, an active internet connection, a device which supports Amazon Alexa or a smartphone with the Alexa app installed and an Amazon account.

Linking and set-up

In the Amazon Alexa skill store, you'll find our eNet SMART HOME skill; activate it and link it to your "My eNet" user account. Find your connected eNet devices via the Alexa app or your Alexa device and from this point on you can control your devices via Alexa. The device designations are always made up of the "Room designation from your eNet system" + "Corresponding device designation from your eNet SMART HOME app" = Device designation in Amazon Alexa.

Functions

Via Amazon Alexa, you can switch devices and sockets on and off, turn lights on and off or dim them, raise and lower blinds, roller shutters and awnings completely or to a % value of your choice (if you use blinds with adjustable slats, you can set the position of the slats), activate any scene created in your eNet SMART HOME app and control your rooms via group commands.





2. VOICE CONTROL VIA GOOGLE ASSISTANT

In order to use the Google Assistant voice assistant with eNet SMART HOME, you need an eNet server, the installed eNet SMART HOME app, a My eNet account with activated free-of-charge remote access, an active internet connection, a device which supports Google Assistant or a smartphone with the Google Home app installed and a Google account.

Linking and set-up

In the Google Assistant action store, you'll find our eNet SMART HOME action; activate this action and link it to your "My eNet" account. Find your connected eNet devices via the Google Home app or your Google Assistant device and from this point on you can control your devices via Google Assistant.

The device designations are always made up of the "Room designation from your eNet system" + "Corresponding device designation from your eNet SMART HOME app" = Device designation in Google Assistant.

Functions

Via Google Assistant, you can switch devices and sockets on and off, turn lights on and off or dim them, raise and lower blinds, roller shutters and awnings completely or to a % value of your choice (if you use blinds with adjustable slats, you can set the position of the slats), activate any scene created in your eNet SMART HOME app, control your rooms via group commands and query the device status of your devices.

PLANNING AND COMMISSIONING

All the previously known steps for planning electrical systems can be applied 1:1 for eNet installations. The planning of an eNet system is, therefore, no different in principle from the planning of other electrical systems. In any case, functions must be defined, devices planned, installation locations defined, and cables to the electrical consumers laid, fused and wired.

Discussions with the customer form the basis of the planning process, as well as the architect's and the electrical engineer's plans, for example, if necessary. Devices and device settings – for staircase lighting (automatically off), wind and rain alarms for awnings, or skylights, etc. – are arranged based on these plans.

Naturally, eNet isn't just suitable for new systems or structurally restored buildings where the entire electrical installation has been replaced. Particularly when it comes to retrofitting operations in building stock, customers are keen to re-use existing cables, socket outlets and so on, and to encounter as few restrictions as possible during the conversion phase due to noise, dirt or specialist tradesmen.

1. PHASE 1: DEFINING FUNCTIONS

First of all, the system's desired functionality must be clarified. This essentially involves taking note of the customer's requests and requirements – firstly regarding the functions to be implemented.

Where are they to be controlled? Which functions should be accessible from which device? What automatic functions, scenes or other system functions are desired?

Even at this point, it is useful to ask questions about how the additional eNet SMART HOME functions which are impossible or very difficult to implement with conventional technology would be used:

Examples of functions:

• Living room – ceiling light	Dimming the light
• Living room – window	Moving the roller shutter
• Living room – Heating	Controlling room temperature
• Bedroom – Heating	Controlling room temperature
• Hallway – wall light	Switching the light

- Operation via smartphone or tablet – local or remote access – desired?
- Fully encrypted eNet wireless communication desired?
- Time functions desired? (Switch-on/switch-off delay, staircase lighting time)
- Scenes that can be created, changed and called up using the app?
- Logic function desired? ("If-Then rules")
- Should roller shutters, awnings or blinds be moved to certain positions?
- Physical sensor functions required? E.g. motion detector or wind alarm
- Centralised functions for lights, climate control or blinds, and for individual areas/rooms, desired?
- Timing functions required? (Astro function)

If the architect has drawn up a plan for the electrical installation, it will already contain specifications for socket outlets, operating stations, device connection boxes and so on. The installation engineer's job is also to flesh out the plan for eNet devices.

Operating station Function

Living room – door	Ceiling light, roller shutter on window, roller shutter on door
Bedroom – door	Ceiling light, bedside lamps, roller shutter
Bedroom – bed	Turn on all lights ("panic switch")
Bedroom – bed	Ceiling light

2. PHASE 2: SELECTING DEVICES

The second phase firms up the implementation of the customer's requests and requirements by selecting devices. Devices are selected based on the requirements regarding the loads to be operated, the functions, the design requirements (operating stations) and, if necessary, the installation possibilities (e.g. flush-mounted or DIN rail-mounted devices).

Evaluating installation locations

If possible, the installation locations should be evaluated during the planning stage. DIN rail-mounted devices need space on a sub-distributor; concrete ceilings with metal reinforcement attenuate the wave propagation to a greater extent than wooden ceilings. The same applies to mineral plasters or cavity walls based on metallic cavity frames.

Rules for installation locations

- Avoid shading, reflections and the suppression of wireless signals (e.g. due to solid ceilings and walls).
- Keep distances between transmitters and receivers short.
- Do not install transmitters and receivers close to the ground.
- Keep distance from larger metal surfaces such as doors, frames, aluminium roller shutters, ceiling panels, distribution cabinets, insulating foils and ventilation grilles.
- Keep distance from sources of radio interference, such as electronic ballasts, motors and Tronic transformers.
- Keep distance from other radio services, e.g. cordless phone, wireless headphones.

Take damp surfaces such as freshly plastered or papered walls into consideration, because they also attenuate wireless signals.

3. PHASE 3: INSTALLING THE SYSTEM

If it is sufficient to connect transmitters and actuators to one another to implement the customer's requests and requirements, or

perhaps to switch the operating mode too, the installation engineer can choose the commissioning method they prefer.

More comprehensive functions offering greater convenience are implemented with the eNet server and the eNet SMART HOME connect commissioning interface.

	Manual commissioning	eNet SMART HOME connect
Connecting transmitters and actuators	✓	✓
Switching the operating mode	✓	✓
Adjusting running times, adjusting the dimming principle	✓	✓
Smartphone-based operation	–	✓
Advanced operating modes	–	✓
Adjusting parameters	–	✓
Smart home scenes	–	✓ + app
If-Then rules	–	✓ + app
Time functions	–	✓ + app
Timing (Astro function)	–	✓ + app
Documenting the system	–	✓
Diagnostic functions	–	✓
Displaying measured values	–	✓
Energy sensors	–	✓
Remote access	–	✓ + app
Fully encrypted wireless communication	–	✓
Load management	–	✓ + app

Room	Where	Device
Upstairs sub-distributor		Dimming actuator, 4-gang
Living room	Roller shutter on the window	Mini blind actuator
Bathroom	Underfloor heating system	Smart thermostat
Living room	Radiator	Smart radiator thermostat
Bedroom	Door	Wall transmitter, 3-gang
Bedroom	Middle of the bed	Wall transmitter, 1-gang "Everything"

4. MANUAL COMMISSIONING

In many applications, it is sufficient to set the eNet device's operating mode and to connect the transmitter and actuator functions to one another afterwards. A "project design" may then be limited to the list of functions and connections, or may be completely unnecessary.

Setting the operating mode

Hand-held and wall transmitter buttons must be set to a normal button or scene function.

Generally speaking, actuators have one operating mode switch. Depending on the device, it is also used to set other parameters, such as shading solution running times for blind actuators, or to adapt the load type for dimming actuators.

For installation environments that are not easily accessible, it is advisable to turn the operating mode switch to the PC position following commissioning. Subsequent changes to the device settings can thus be made using the eNet server without an excessive amount of installation work.

Manually connecting transmitters and actuators

1. Put the actuator into Programming mode.
2. Put the transmitter into Programming mode.

3. Press the desired operating button on the transmitter.

The transmitter and receiver save the connection.

The transmitter and receiver exit Programming mode.

Up to ten actuators can be connected to a transmitter in a single process. To this end, the ten actuators must first be put into Programming mode one after the other. Then, the transmitter is put into Programming mode and the desired transmitter button is

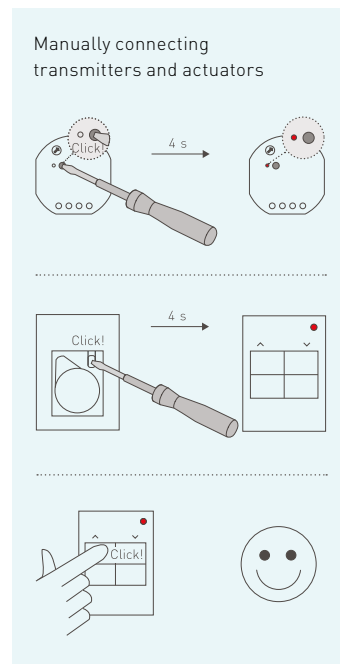

pressed. The transmitter button is now connected to the ten actuators.

Because devices exit Programming mode again after one minute of inactivity, the distances may have to be considered from a temporal standpoint for installed devices.

5. COMMISSIONING WITH THE eNet SERVER

If, for example, processes involve

- operating eNet devices using a smartphone or the remote access solution,
- activating advanced operating modes or setting device parameters,
- implementing automatic functions (If-Then rules, timing functions, etc.),
- implementing blocking functions or time functions,

the path leads through the eNet server. eNet SMART HOME connect, the graphical commissioning solution, allows the user to clearly create connections between eNet devices, set device parameters and document the entire system.

Setting the operating mode on a PC

Prior to commissioning with the eNet server, the devices' operating mode switches should be put into the PC position so that the operating mode can be changed from the server.

Preparing a device for commissioning with the server

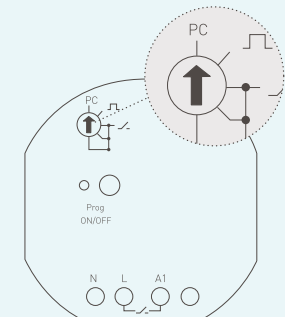

Commissioning using eNet SMART HOME connect

Once the building structure has been created, devices can either be added by performing a device search from the installation or from the eNet server catalogue. Catalogue devices are practical to use if the system is designed beforehand at a desk. Catalogue devices must, however, be exchanged for real devices later on in the installation process.

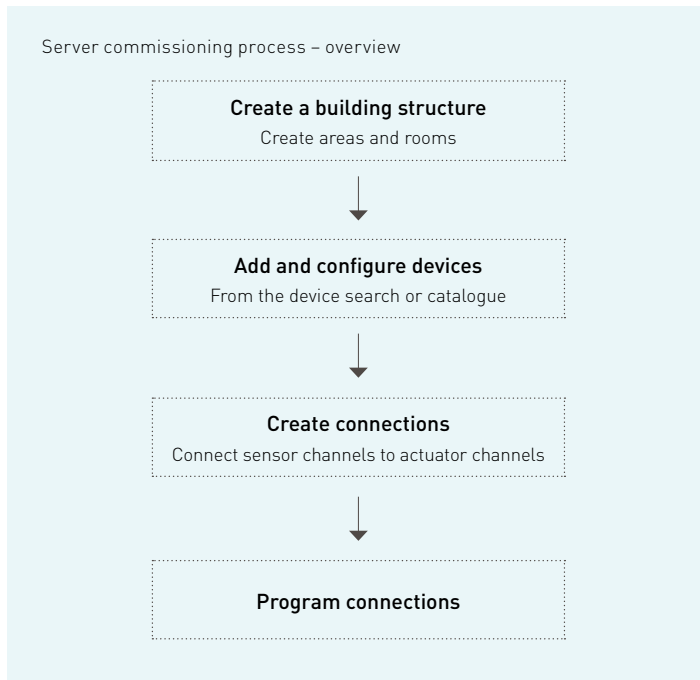

The devices are then assigned to the room they were installed in (device location). The individual device channels are each assigned to the room they “have an effect on” (channel location). The channel location is shown in the app later on. The device location of a 4-gang DRA switching actuator may, for example, be “Cellar”, while its actuator channels may be assigned to the living room, bedroom, working room and bathroom channel locations.

The device parameters can be used to change the operating mode, con-

figure settings and activate additional functions such as the switch-on or switch-off delay.

In the next step, permanent device connections between transmitter and actuator channels are created in the SMART HOME connect commissioning interface. These device connections are not shown in the app and cannot be changed. Installation engineers can thus use device connections of this type to create a stable and reliable basic eNet installation that cannot be intentionally or accidentally modified by the customer. Connections be-

tween transmitters and actuators also remain active if the server is switched off or removed from the system.

End customers can link transmitters and actuators with the app using If-Then rules. But for this to happen, the sensor channels must be configured for this use during the commissioning process.

Programming connections

As a last step, the settings and connections made must be programmed in the devices. Battery-operated devices (e.g. hand-held transmitters) must be woken up for this by means of brief operation on the device. During the installation process, battery-operated devices do not remain permanently accessible via wireless contact. They only activate their wireless capability briefly and at regular intervals so that their batteries do not go completely flat. Battery-operated devices shut down their programming capability and switch back to Power-saving mode as soon as eNet SMART HOME connect is closed.

Settings with eNet SMART HOME app

An eNet system handed over by the installation engineer can be modified by the end customer to include scenes, timing functions and If-Then rules and adapted to suit their individual needs at any time. Individual device parameters such as run-on times can be changed in the app too. It is also possible to add partner systems, e.g. tado° Professional. Moreover, individual device parameters, e.g. run-on times in the app, can be changed.

Examples of timing functions:

- The lights in the kitchen, garden and living room are automatically switched on when the sun sets (Astro function)
- The lights on the ground floor and in the garden are switched off at midnight
- The roller shutters on the ground floor open when the sun rises, but not before 6 am

Examples of If-Then rules:

- If the light intensity on the outside motion detector falls below 35 lux at twilight, then the outside lighting switches on
- If scene button 1 is pressed on the wall transmitter at the bedside in the bedroom, then all the lights in the house and garden are switched on

Automation functions in the eNet SMART HOME app

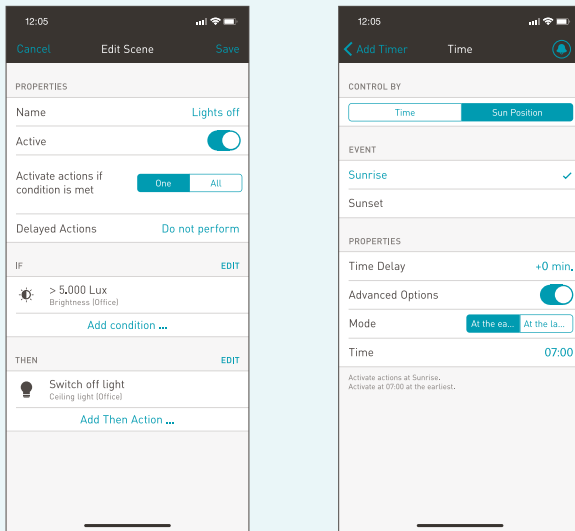

Example of implementing a night light function as a combination of two time programs and one If-Then rule:

- Every day at 11.30 pm, a time program activates the following If-Then rule, which is deactivated again when the sun rises:

If the scene button on the wall transmitter in the hallway is pressed, then the light in the hallway switches on at just 20 % for 10 minutes.



SERVICE AND DIAGNOSTICS

An installation should be expanded or modified during servicing. In principle, the same rules apply here as to planning and commissioning.

In the case of defective installations with unclear errors, the solution proceeds with systematic troubleshooting. Sources of errors in eNet systems include:

- Faulty installation
- Faulty device function (transmitter or actuator)
- Faulty programming
- Incorrect parameter settings
- Blocking functions
- Incorrectly defined automatic functions
- Missing or impaired wireless connection

While incorrect installation or faulty device functions can generally be localised and rectified

using the installation engineer's known methods, an eNet server is needed to inspect and – if necessary – correct parameter settings. The installation engineer provides additional tools which can be used to assess wireless links and record telegrams, for example. The eNet SMART HOME app is also needed to inspect and, if necessary, correct automatic functions.

1. SERVICE CASES

Replacing a device

Following a device defect and replacement, the device must be re-commissioned. Once the operating mode has been set, this involves setting the device parameters and connecting to the other transmitters or actuators.

If a defective device can still be read in by means of a device search us-

ing the eNet server, its data can be transferred to a new device.

In an eNet SMART HOME system, all the devices' data is saved in the project. A defective device can thus be directly replaced with a new one. To do so, only the "Replace device" option must be selected when adding the new device to the project.

Removing a device

If a device is to be removed from a system, it is advisable to disconnect the connections to other devices beforehand. The same applies to situations where a device is being reset to its delivery state.

"Half connections"

If devices that are connected to one another are not disconnected from one another properly before being removed, replaced or reset to the factory settings, the connection data is generally retained in the device memory. This can cause the following problems:

- The connection tables in the devices are blocked, and no other connections can be created.
- The remaining wireless transmitter does not receive the removed actuator's expected status feedback and indicates a transmission error.

"Half connections" such as these are removed from a device by re-

setting it to the factory settings. Because this also disconnects the intact connections to other devices in the system, these connections must logically be deleted beforehand. The desired connections can be re-established after the reset.

If an eNet server is available, time and effort can be minimised by scanning the device and all the devices connected to it and reconfiguring them using the commissioning interface.

Exceeding the permitted transmission cycle

As they are only "short-range devices", eNet devices may only transmit for a fixed given period of time within an hour. This maximum permissible transmission time forms part of the wireless communication licence and takes all of a device's transmission activities into consideration.

The transmission times arising each time a device is operated are totted up separately by every eNet device. In this regard, its transmission management evaluates short, periodic time frames and limits the eNet device's transmission behaviour to its basic function when a limit is reached. The basic function includes operating commands, for example, while status queries are – in contrast – switched off for a short time.

The user recognises active transmission limitation due to the fact that, following multiple operation, a transmission error is indicated instead of the actuator status, even though both the system and the actuators are working properly.

In a normal situation, the limitation is usually cancelled again automatically after a few minutes. If transmission is frequently limited during normal use of an eNet device, the following measures, for example, may remedy the issue:

- Use of an eNet repeater. If transmitters and actuators are at the limit of their wireless range, cumulative telegram repetitions may become necessary. In this situation, an eNet repeater increases the transmission security and can thus shorten a transmitter's transmission period.
- Supplementing an eNet system with an eNet server. In an eNet SMART HOME system, the modified functional concepts lead to optimised system behaviour, which may also result in short transmission times.

2. SYSTEMATIC TROUBLESHOOTING

In principle, an error can occur on any component involved in an electrical function. If the cause of an error is not immediately obvious (e.g. lamp defective), the process may be based on the error chain, which is systematically worked through one item at a time.

Overview

1. Check the device's power supply
2. Check that actuators are working
3. Check that transmitters are working
4. Check the wireless transmission
5. Check the project design: Check set parameters. Check the operating mode switch. Were the device settings loaded in the devices too?
6. If an eNet server is used in the system:
 - a. Check central functions
 - b. Check connections and If-Then rules
 - c. Check scenes

Error chain

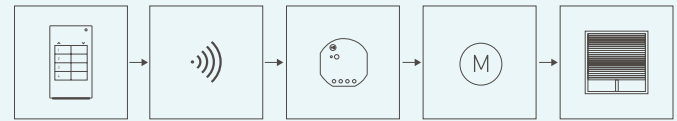

d. Check priority functions

e. Check time programs

The error pattern can be increasingly narrowed down by asking specific questions:

- Does the error always occur?

If not:

- Can the error's occurrence be limited to a certain time?
- Is the error associated with other factors or events? For example: Sunset; when controlling another function.
- The error has existed since a specified point in time.

The simultaneous occurrence of several errors may indicate a common cause; the interface of these functions interface should then be taken into consideration, e.g. a common switching device, a common automatic circuit breaker, repeater, etc.

Checking that actuators are working

If the device is supplied with power, the function of the switching device – i.e. the actuator – is checked in the next step.

- Can the actuator be operated with the operating button?
- Is the operating mode switch in the right position?

For DIN rail-mounted devices:

- Is the device connected to the DRA receiver module or the eNet server?
- Are the device and the DRA receiver module supplied with power?
- Is an external antenna connected to the DRA wireless receiver module (advisable with metallic distributors)?
- Can the actuator be reached using wireless communication?

- Does the actuator respond when it receives a telegram?
- Does the function depend on several transmitters?

If the operating mode switch is in the PC position:

- Is the actuator parametrised correctly?
- Are the required connections to the transmitter programmed correctly?
- Are blocking functions or other priority functions activated in the actuator?
- Are the eNet server's settings loaded in the actuator?

If the operating mode switch is in the PC position, the actuator is generally programmed individually. Adjusting the operating mode switch may cause the set data to be lost. In this situation, it is advisable to load the project design data in the actuator again. If the project design data is not available, the actuator should be read out and checked by an eNet server using a device search.

Checking that transmitters are working

If there is no malfunction present on the actuator side, the transmitter side should be examined for errors. If the function depends on several transmitters which are logically linked to one another via the eNet server or via eNet rules, for example, the troubleshooting process must naturally include all the affected transmitters – including the automatic functions.

- Does the transmitter transmit when pressed?
- Battery or accumulator-operated transmitters: Is the battery or accumulator flat?
- For universal transmitters: Is the transmitter supplied with power? Have circuit breakers or residual current-operated devices – on the transmitter side – tripped?
- Does the function depend on several transmitters?
- Is the operating mode switch in the right position?
- Is the transmitter parametrised correctly?
- Are the required connections to the actuator programmed correctly?

Error on the wireless transmitter?

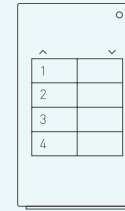

- Are the eNet server's settings loaded in the device?

If the transmitter's operating mode switch is in the PC position, it is generally programmed specifically. Adjusting the operating mode switch may cause the set data to be lost. In this situation, it is advisable to load the project design data in the transmitter again. If the project design data is not available, the transmitter should be read out and checked by an eNet server using a device search.

Checking the wireless link

If all the components are working perfectly on both the actuator and the transmitter side, the source of error remains the wireless transmission itself.

- How long is the wireless link between the transmitter and the actuator?
- Are shielding materials installed on the wireless link?

In this regard, concealed metal content is of particular interest – for example reinforced concrete, flush-mounted boxes with a conductive coating, distribution cabinets, lightweight construction walls with a stud frame underneath, metallised insulating materials, or aluminium roller shutters. Surrounding parts of the electrical installation and the existing furniture may also have an attenuating effect on the wireless signal.

If structural obstacles cannot be eliminated, the use of repeaters may help.

Another measure involves placing conventional push-buttons, which are connected to an eNet universal transmitter, on site. The transmitter can be mounted a few metres away in a location that is better suited to wave propagation.

Error on the transmission path?

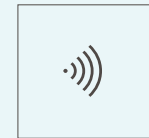

The same applies to eNet actuators installed in a location that is more favourable for wave propagation.

3. TROUBLESHOOTING TOOLS

Recording wireless telegrams with the eNet server

The eNet server can be used to record the eNet transmitters' wireless telegrams and to display them along with the time and date in eNet SMART HOME connect, the commissioning interface. It is also possible to export all the recorded telegrams in order to run an evaluation with another piece of software. In the process, time stamps and additional project data are added to the telegrams:

- Time at which the eNet server received the telegram
- Device UID, a freely allocated number that is allocated in a device-specific manner
- The device's serial number, which can also be viewed in the Information window
- Device type, as an abbreviation of the device name
- Device name, which is also shown in the device display
- Device location and device designation
- Channel number, type, location and name of the device channel that sent the telegram

- Indication as to whether the telegram was received by a repeater

eNet diagnostic device

A simple tool is made available for the installation engineer in the form of the eNet diagnostic tool.

The eNet diagnostic device can be used to detect external wireless communication in the 868.3 MHz frequency range, receive telegrams from wireless transmitters and repeaters, and also receive status messages from wireless actuators and evaluate them in terms of their signal strength.

The device provides support during the manual commissioning of an eNet installation by helping to evaluate the building conditions before and during commissioning. Installation locations can be evaluated and dead spots can be detected using the diagnostic device. The device can also help with optimally positioning a repeater and with switching the repeater function of mains-supplied eNet devices on and off.

Determining the wireless signal strength with the eNet server

If a wireless signal is attenuated too much, the signal strength upon reaching the receiver is no longer sufficient for error-free reception. The attenuation of wireless signals depends on:

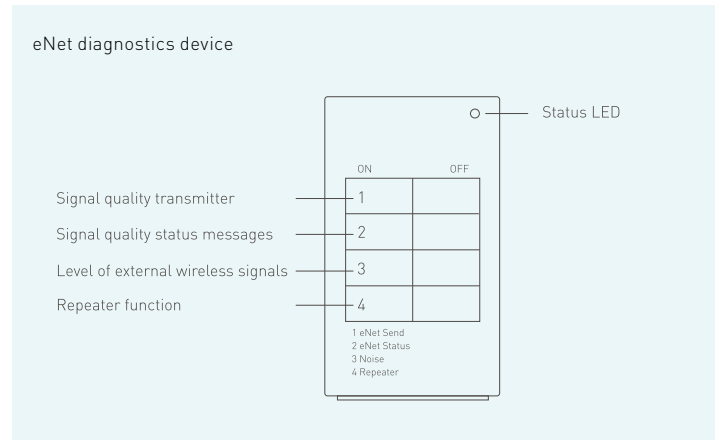

- The power effectively radiated by the transmitter
- The transmission path
- The height of the antenna and the alignment of the transmitter and receiver
- Overlapping due to reflected signals

To assess a wireless link, the eNet server can determine the signal strength of received telegrams. The measurement process itself is carried out by the receiving eNet devices. Connections between one transmitter and up to four receivers can be assessed at the same time in a single step. The eNet server controls the diagnostic function workflow after first selecting transmitters and receivers in the commissioning interface.

The result is shown in three levels:

- No reception
- Sufficient reception
- Good reception

If the signal strength does not meet the requirements, measures should be taken to improve the wireless link, such as changing the installation location, using repeaters, minimising interfering interfaces caused by metallic parts or other devices, etc.

For wireless connections of "sufficient" quality, it should if necessary be critically considered whether influences that are still impossible to predict during the construction phase may impair the quality of the wireless connection. If, for instance, the building owner prefers metal furniture in a meeting room, or if a side room

containing steel cabinets is to be used as an archive, a connection that is already weak anyway could be negatively affected by this.

Repeaters

Repeaters are used to repeat received wireless telegrams and to thus increase the system range and the possible distance between the transmitter and the actuator. It is useful to use a repeater roughly halfway between the actuators and sensors whose communication is to be improved or whose wireless range is to be increased.

The installation engineer can activate the repeater function with a mains supplied eNet device on the radio link. Alternatively, a separate repeater can be set.

No more than two devices should work as a repeater within an eNet system, so as not to excessively load the wireless channel.

Using a separate repeater

A separate repeater (no longer available for reorder) supports two types of functions:

When simply used in the system, it repeats all the received wireless telegrams – just like the wireless actuators with a repeater function.

The repeater can also be directly connected to wireless transmit-

ters. In this situation, it only repeats the telegrams from those wireless transmitters that are “personally known” to it. This operating mode leads to far less wireless traffic and is preferable to repeating all the wireless telegrams.

Activating the repeater function in an eNet device

Mains-operated eNet devices – i.e. actuators or a universal transmitter, for example – have a repeater function that can be activated by the installation engineer if necessary. Devices with an activated repeater function repeat all the received wireless telegrams, regardless of whether they are intended for them or not. One wireless telegram can be repeated a maximum of two times within an installation. This ensures that a telegram is only repeated by a repeater once.

eNet repeater as an adapter plug*

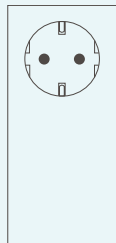

* No longer available for reorder.

... with the eNet diagnostic device

The repeater function can also be activated or deactivated without the eNet server – by using the diagnostic device:

- The eNet device is first put into Programming mode. The eNet diagnostic device establishes the connection automatically.
- The repeater function can now be activated or deactivated using the diagnostic device.

... with the eNet server

Activation is carried out using the “Repeater mode” device parameters, which are changed in the eNet SMART HOME connect commissioning interface using the eNet server.

4. TROUBLESHOOTING IN SYSTEMS WITH REPEATERS

In a system containing eNet repeaters, there may also be an error in the repeaters’ function. A check should take the following aspects into account:

- Is the repeater still available in the system?
- Is the repeater still in its original position, and is it being supplied with power around the clock?
- Has the repeater been blocked with shielding materials?

- Is the repeater connected to the eNet devices whose wireless signal it is supposed to be repeating?

5. CONNECTION WITH THE eNet SMART HOME app

If the connection from a smartphone or tablet to an eNet system is interrupted, the aspects should be checked:

- Is the smartphone or tablet logged onto the same network (or WLAN) as the eNet server?
- Has the correct eNet server been selected in the eNet SMART HOME app? There may be several eNet servers in a single network. Check the serial or IP address of the selected eNet server.
- Are the username and password in the eNet SMART HOME app correct?
- Is there a WLAN connection, and are the selected SSID and the WLAN password correct?
- How many smartphones and tablets are already logged onto the eNet server?

Observe the system limits.

- What version of operating system does the smartphone or tablet use, and is it supported by the app?

Update the device software if necessary.

- What version of operating system does the smartphone use, and is it supported by the app?

The following points should also be checked when using the remote access system eNet SMART HOME remote:

- Is eNet SMART HOME remote set up correctly and activated in the app?
- Is the eNet server registered on my.enet-smarthome.com?
- Is the smartphone or tablet connected to the internet, and is the eNet server connected to the internet?
- Is the "Allow remote access" setting activated in the eNet server's system settings?

6. REMOTE MAINTENANCE VIA eNet SMART HOME remote

In eNet SMART HOME systems, the help of specialist tradesmen – whether they are professional electricians or the factory customer service team – can in principle be obtained via remote access, without any need for them to be present on site.

But for this to happen,

- the eNet server in the system must be connected to the internet via a WLAN router, and
- eNet SMART HOME remote must be set up for the system.

If servicing is required, the customer can allow the installation engineer access to their system, so that they can check and correct the settings in the eNet server and in the devices if necessary.

This access is structured so that the user of the eNet system has to expressly grant third parties access to it.

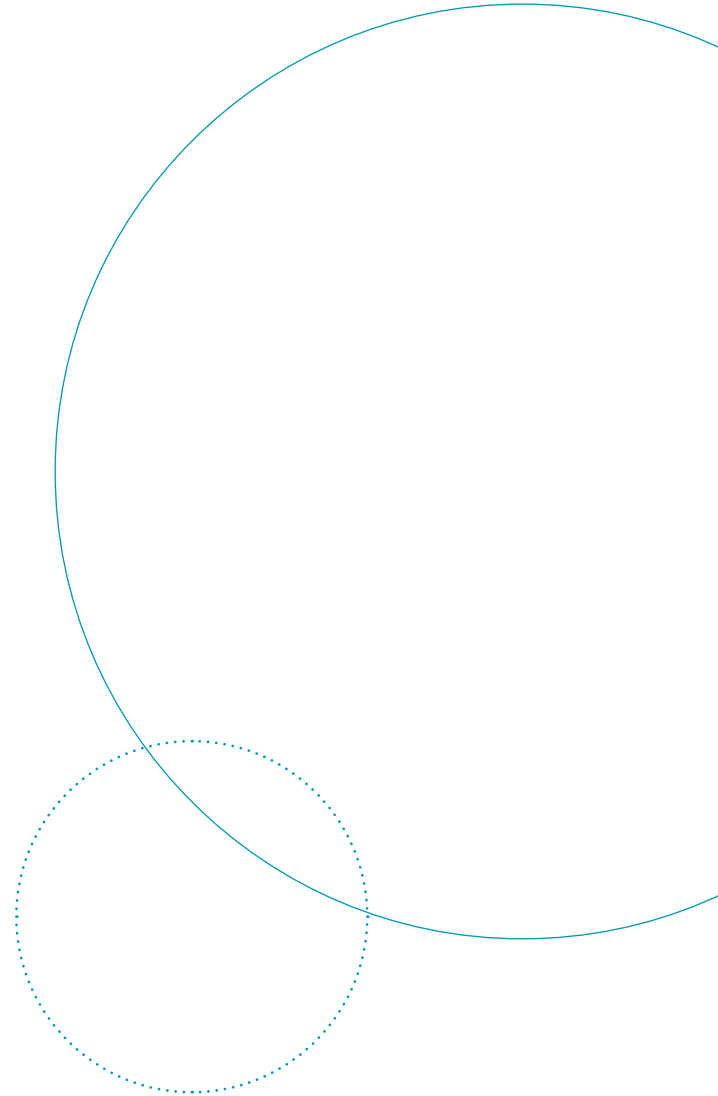

SAMPLE APPLICATIONS





THE PERFECT ATMOSPHERE FOR A COSY FILM NIGHT

Description:

- A light switch is replaced with an LED universal touch dimmer with an eNet centre plate.
- A blind control is replaced with a 230 V blind control with an eNet blind centre plate.
- An eNet wall transmitter, 1-gang, is installed.
- The TV scene is activated with the wireless wall transmitter, 1-gang, which not only switches on the light at a specific brightness level, but also lowers the blinds and sets the smart heating system control from tado° Professional, for instance, to 21°C.

Gira product examples:

- LED universal touch dimmer
- eNet wireless switching unit or dimming unit, 1-gang
- Use of 230 V blind control
- Net blind radio centre plate
- Wireless wall transmitter, 1-gang, with inscription space
- eNet server
- Smart radiator thermostat



COMFORTABLE TEMPERATURE SETTING IN ALL ROOMS VIA FIXED OPERATING PANEL

Description:

- An operating panel is mounted in the hallway, for instance, and connected to the router.
- An eNet server is connected to the router.
- tado° room thermostats are installed in every room, enabling direct, onsite operation at all times.
- The eNet app makes it possible to control the heating zones via the operating panel as well as via further smartphones and tablets – on a room-by-room or floor-by-floor basis, or for the entire flat, the choice is yours.
- Scenes let you select the desired temperature profile at the press of an operating panel button, e.g. for holidays, film nights or day-to-day routines.

JUNG product examples:

- Smart Control 5"
- eNet SMART HOME app
- tado° Smart Thermostat Professional
- eNet server

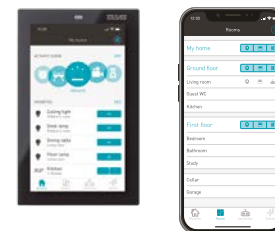



LIGHT DIMMED AT NIGHT IN THE BATHROOM AND IN THE HALLWAY

Description:

- The light switch is replaced with an eNet dimming actuator Mini and an eNet wall transmitter.
- If the wall transmitter's left button is pressed, the "Daylight" rule switches the light to 100%; the "Night light" rule switches it to 20%. The "Light off" rule switches it off as soon as the right button is pressed.
- At 11 pm, the "Night light" timing function activates the "Night light" rule and deactivates "Daylight". The "Daylight" timing function deactivates "Night light" at 6 am.
- That way, you can go to the bathroom at night without experiencing any glare, because the light is dimmed to just 20% when switched on between 11 pm and 6 am. The rest of the time, it is set to 100%.

Gira sample product (s):

- eNet server
- eNet SMART HOME app
- Gira G1
- Wireless dimming actuator, 1-gang Mini
- Wireless wall transmitter, 1-gang with inscription space



CONTROLLING YOUR HOME WITH YOUR SMARTPHONE WHEN AT HOME AND ON THE MOVE

Description:

- The server is connected to the internet via the router using either WLAN or the network cable.
- Smartphones connect to the server via WLAN using the app.
- Switching, dimming and blind actuators are installed for the functions.
- Wall transmitters are installed for local operation.
- The app enables all building functions to be controlled directly. Automatic functions such as scenes, rules and schedules provide support with this in the app.
- eNet SMART HOME remote allows you to control your home when on the move.

JUNG sample product (s):

- eNet server
- eNet SMART HOME app





GLASS FRONT WITH
eNet WALL TRANSMITTER

Description:

- A grid-bound switch cannot be installed due to the architecture (e.g. glass front).
- Installation of an eNet wall transmitter with a set of floor panels.
- The set of floor panels enables adhesive mounting on smooth or transparent surfaces (such as glass).

Gira sample product (s):

- Wireless switching or push-button actuator, 8-gang/blind actuator, 4-gang
- Wireless wall transmitter, 3-gang with inscription space

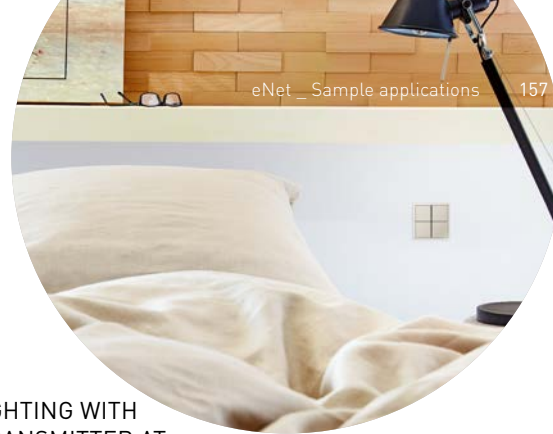

BEDROOM LIGHTING WITH
eNet WALL TRANSMITTER AT
THE BEDSIDE

Description:

- Light switch on the door is replaced by a flush-mounted insert and an eNet operating top unit.
- Additional battery-operated eNet wall transmitters enable the ceiling light to be controlled wirelessly.
- The light can thus be conveniently switched on or off from the bed.
- Wall transmitters can also be attached to furniture such as a bedside table.

JUNG product example:

- Standard LED touch dimmer (1710 DE)
- eNet wireless wall transmitter, 1-gang, F 40
- eNet radio centre plate (for LB management)

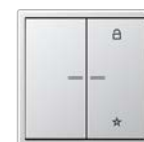



TIME-CONTROLLED BLIND CONTROL USING AN eNet UNIVERSAL TRANSMITTER

Description:

- The eNet universal transmitter is installed in a switch box behind an electronic blind controller (timer).
- The eNet universal transmitter controls the electronic blind control process regardless of the locally set running times.
- The eNet universal transmitter sends the control command to one or more (group control) eNet blind actuators.

Gira sample product (s):

- eNet wireless blind actuator, 1-gang Mini
- Wireless universal transmitter, 2-gang Mini
- Gira electronic blind controller 2



BLIND CONTROL IN GROUPS OR CENTRALLY

Description:

- Central or group blind control, e.g. per floor
- Group control: A button on the eNet wall transmitter can be connected to several eNet blind actuators (per floor).
- Central control: Another button on the eNet wall transmitter can be connected to all the eNet blind actuators in the building.

JUNG sample product (s):

- eNet wireless blind actuator, 1-gang Mini
- eNet wireless wall transmitter module, 4-gang, F 50





AUTOMATIC LIGHT OUTDOORS WITH eNet WALL SWITCH FOR ALL-ROUND LIGHTING

Description:

- eNet motion detectors are installed outdoors and all around the house. The integrated switching actuators are connected to the outside lighting.
- A light is automatically switched on for a desired time when movement is detected in the dark.
- The inside and outside lights can be switched on using an eNet wall transmitter (installed in the bedroom, for example) in an emergency situation.



Gira sample product (s):

- Wireless switching actuator, 1-gang Mini
- Steinel sensIQ eNet motion detector
- Wireless wall transmitter, 1-gang with inscription space



WALL TRANSMITTER IN THE ENTRANCE AREA WITH SCENES FOR "CENTRAL OFF" AND "WELCOME"

Description:

- When you leave the house, you can switch off the lights using a wall transmitter with a "Central off" scene.
- A "Welcome" scene can be programmed too; it switches general lighting on in the house.
- The wall transmitter is installed in the hallway next to the front door.

JUNG sample product (s):

- eNet wireless dimming actuator, 1-gang Mini
- eNet wireless wall transmitter module, 1-gang, F 50





LIGHTING SCENES WITH eNet WALL TRANSMITTERS OR YOUR SMARTPHONE

Description:

- Several lights are controlled by calling up lighting scenes.
- A lighting situation set using a wall transmitter can be saved as a scene by the eNet server using both a smartphone and the app. This scene can be automatically called up every evening using a timing function.
- The blind can be integrated in the "Cinema" lighting scene so that the room darkens automatically.
- When you leave the room, all the lights can be switched off if the button on an eNet wall transmitter is linked to an "Everything off" scene via an If-Then rule.

Gira sample product (s):

- eNet server
- eNet SMART HOME app
- Wireless dimming actuator, 4-gang
- Wireless wall transmitter, 3-gang with inscription space

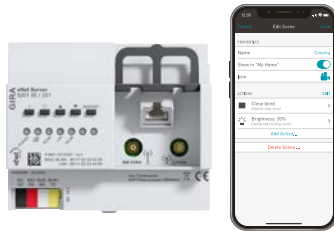

eNet ACTUATORS IN THE DISTRIBUTION BOX

Description:

- eNet actuators and the eNet server are installed in the distribution box. The eNet actuators control the consumers whose supply lines end directly in the distributor.
- Control is via a smartphone or tablet and the eNet SMART HOME app or using an eNet wireless handheld transmitter, for example.
- That way, you can control not only the outside lighting, but also the awning, water fountain in the garden pond, and the garage door.

Gira sample product (s):

- eNet server
- eNet SMART HOME app
- Wireless switching or push-button actuator, 8-gang/blind actuator, 4-gang
- Wireless hand-held transmitter, 4-gang

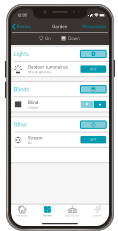



BLIND CONTROL WITH SUN PROTECTION AND TWILIGHT FUNCTIONS PLUS LOCK-OUT PROTECTION

Description:

- A sun/twilight sensor Solar is attached to the window on the south side.
- The sun sensor channel is connected to the blind actuators which switch the roller shutters on the south side. The blind actuators are set so that they are moved to the 50% shading solution height when the sun is strong.
- The twilight sensor channel is connected to all the blind channels, so that the roller shutters lower at twilight.
- An eNet radio centre plate "arrows" is installed next to the patio door so that, before the user leaves the building, the local lock function of the centre plate is activated and this shutter will not automatically close at sunset.

JUNG product example:

- eNet wireless sun sensor Solar
- Standard blinds insert (1730 JE)
- eNet radio centre plate "arrows"



ENERGY CONSUMPTION DISPLAY AND LOAD-DEPENDENT SIGNALLING

Description:

- The washing machine (or the dryer) is in the cellar and the socket to which the washing machine is connected, is monitored via an eNet energy sensor.
- The machine's consumed energy can be viewed in the eNet SMART HOME app.
- The end of the wash cycle is indicated by means of a light in the living room, so there is no longer any need to check in the cellar. The light is controlled using an adapter plug for an eNet switching actuator and an If-Then rule. The rule is triggered as soon as the washing machine switches off and its power consumption drops below 1 W.
- Freezer: Alarm message in the event of device failure.

JUNG sample product (s):

- eNet server
- eNet SMART HOME app
- eNet wireless energy sensor, 1-gang Mini
- eNet wireless switching-push-button actuator, 1-gang Mini





AUTOMATIC STAIRWELL LIGHTING INTELLIGENTLY RETROFITTED

Description:

- The stairwell lighting is to be automatically switched on for a few minutes.
- An eNet motion detector is mounted on the ceiling of the stairwell on the ground floor. No connection cables are necessary since it is battery-operated and communicates wirelessly.
- An eNet wall transmitter F40, 1-gang, is installed on every other floor. The stairwell lighting is controlled via an eNet switch actuator, 1-gang, Mini.
- A connection is programmed between the devices and the desired switch-on time is set on the motion detector.
- The stairwell will now be automatically illuminated when someone enters at the ground floor and it is possible to turn

the lights on at any floor and/or keep them on longer by pressing a button.

- eNet wireless wall transmitter, 1-gang, F 40

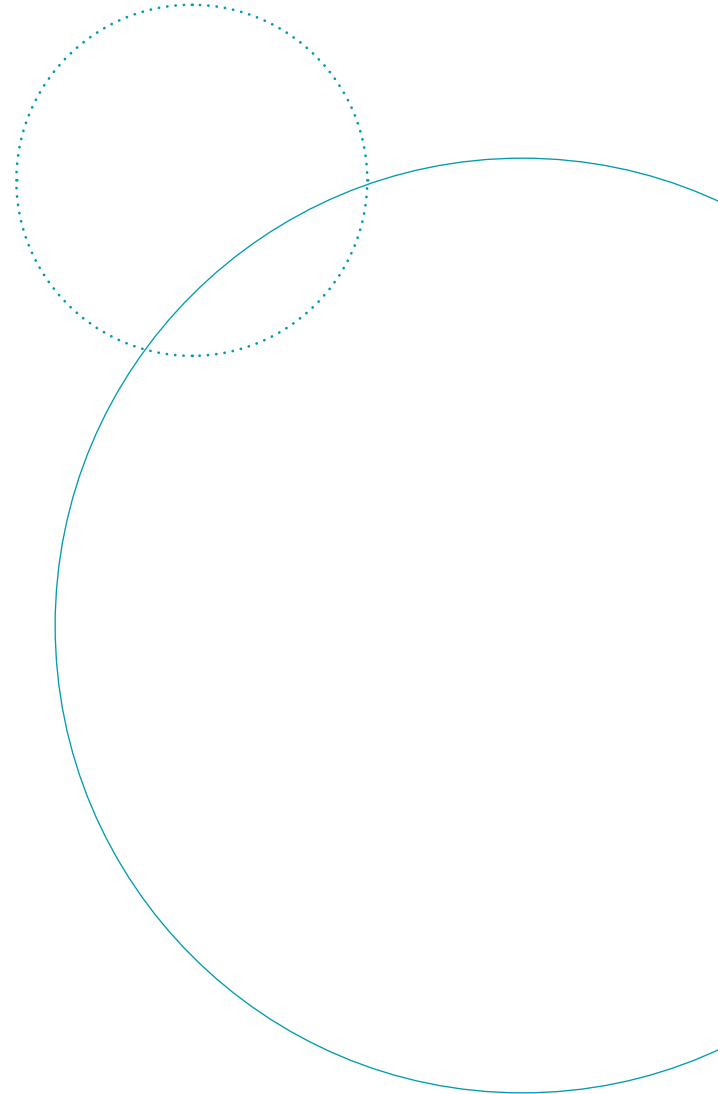

ANNEX

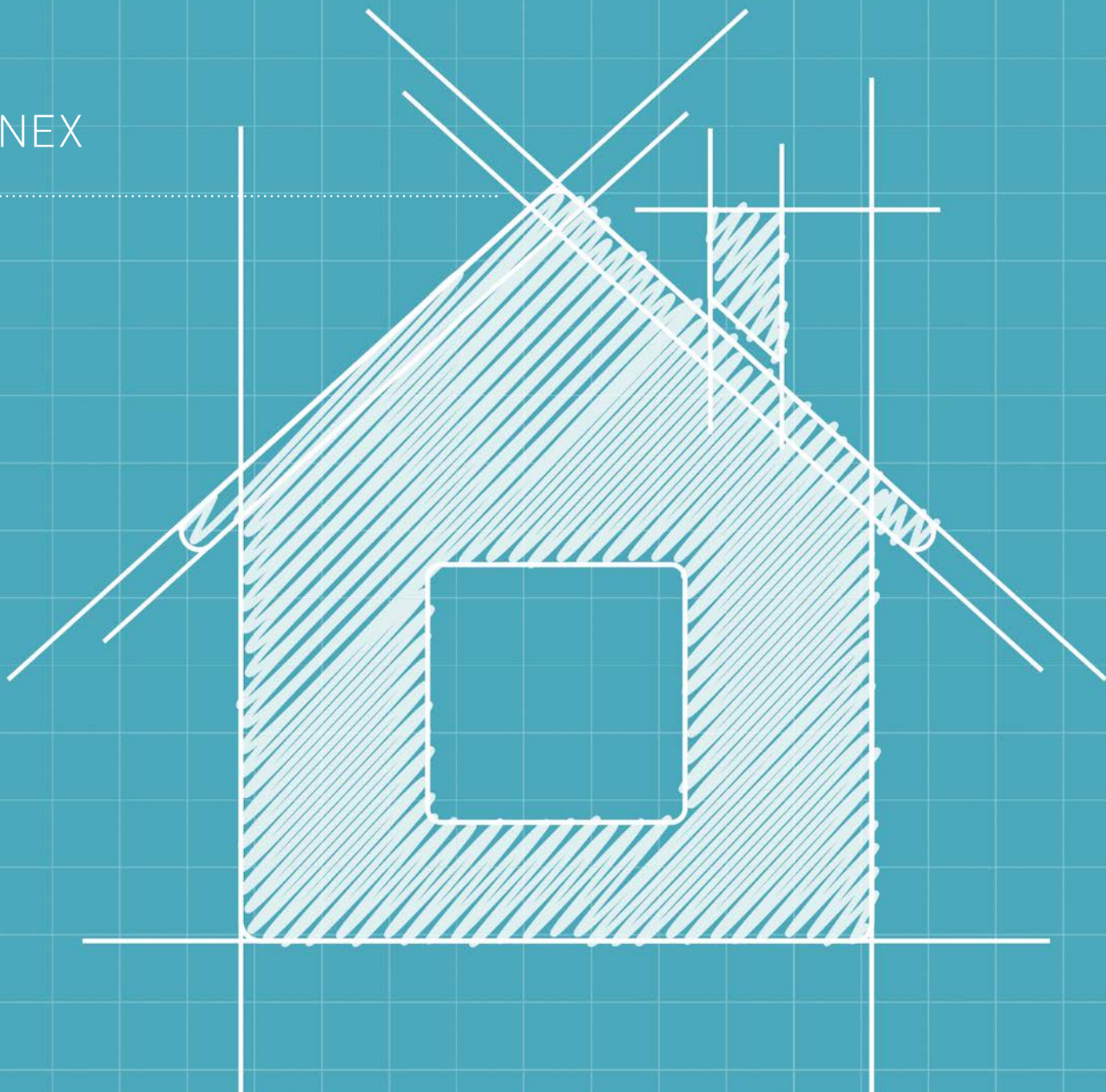

MEDIUM

1. RADIO RADIATION

Radio waves are waves from connected electric and magnetic fields. They are created from changing electric currents when the fields that are changing in response to the changing currents detach themselves from the field-generating source and spread out in the space.

Characteristic data of an electromagnetic field are wavelength λ and frequency f . Between these two parameters, there exists the relationship $c = \lambda \cdot f$, i.e.

the product produces the propagation speed c , $\approx 300,000$ km/s.

As the transmitted energy depends on the frequency, electromagnetic waves of different frequency ranges differ in terms of how they interact with matter. For example the frequency range of visible light is characterised by the fact that the waves have enough energy to stimulate chemical molecules, but without ionising or destroying them.

The term "radio" refers to the frequency range technically used for wireless information transfer, i.e. from approx. 10 kHz to 300 GHz.

Electromagnetic wave – model representation

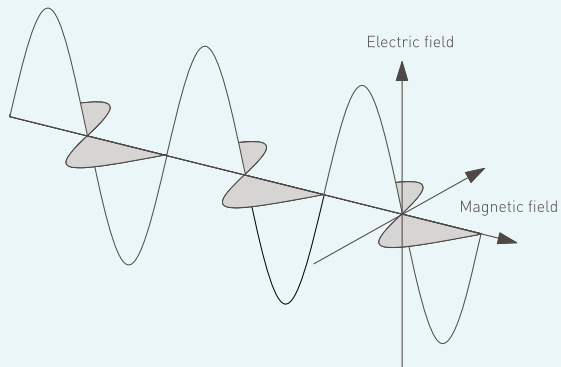

Radio waves with a low to medium frequency do not have enough energy to stimulate matter, but can penetrate building ceilings or walls. Depending on the mass (thickness) and conductivity (metal content, moisture), this is associated with high energy loss to a greater or lesser extent.

2. PROPERTIES OF ELECTROMAGNETIC WAVES

Just like their sources – electric and magnetic fields – electromagnetic waves do not need a medium of their own and spread out in the vacuum at the speed of light. Propagation is always slower in other media.

Electromagnetic waves spread out in a straight line, in all directions within the room. If several electromagnetic waves encounter one another, they penetrate one another without any interference.

Reflection, transmission and absorption of electromagnetic radiation

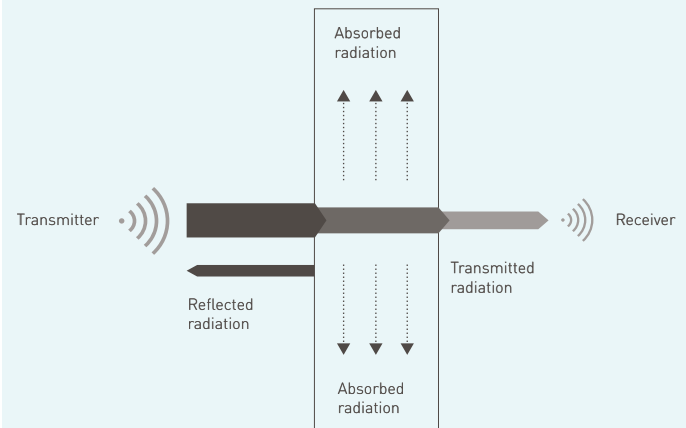

Here, the effects overlap, so that they can intensify or even weaken depending on the phase position.

Reflection, transmission, absorption

If electromagnetic waves encounter matter (or a boundary surface between two different materials), the behaviour depends on the type of matter as well as the frequency of the wave. The radiation can penetrate the material, or be absorbed or reflected by it.

Electrically conductive materials cannot be penetrated by electromagnetic waves. This is why we use metal shielding to keep an area free from radio waves. However, metal contents also have a shielding effect in buildings – in furnishings or in steel reinforcements in concrete, for example.

Refraction

When a material such as a wall is penetrated, the propagation speed changes due to this material's electrostatic properties. As a consequence of this, the electromagnetic waves' direction of propagation changes and the radiation route curves. This phenomenon is well-known in visible light – if you observe a body lying in water, it appears to be lying closer to the surface of the water, for example. Refraction is used for all kinds of optical instruments such as lens-

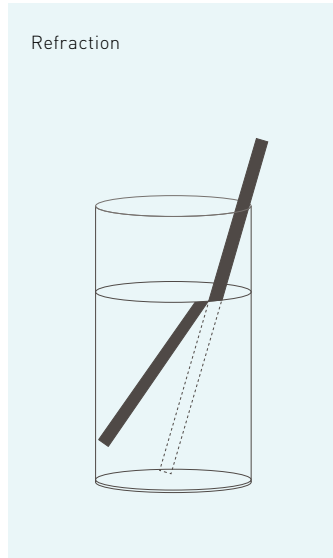

es, glasses, microscopes, prisms and so on.

Diffraction

When passing through an obstacle, electromagnetic radiation also experiences deflection. When it comes to radio radiation, this is expressed in such a way that signals can still be received in spite of this in an area behind an impenetrable obstacle. Diffraction is also always associated with interference, so that areas with and without reception develop.

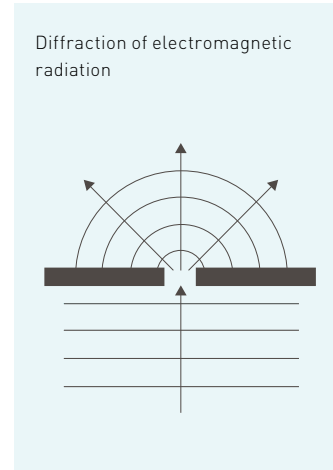

3. PROPAGATION AND ATTENUATION OF WIRELESS SIGNALS IN BUILDINGS

Wireless signals are attenuated by various influences on their way from the transmitter to the receiver. For the transmitter and receiver to communicate, naturally the transmitter's wireless signals must still have sufficient energy for the transmitter to still be able to evaluate the signals.

Wireless range

The following parameters determine the wireless range:

- The power effectively radiated by the transmitter (ERP = "effectively radiated power")

- The attenuation on the transmission path
- The height of the antenna
- Influences caused by overlapping with reflected radiation
- The characteristics of the transmitter and receiver antennae, described by the antenna factor
- The alignment of the transmitter and receiver antennae to one another, in connection with the polarisation of the radio radiation.

Radiated power

The manufacturer of a wireless transmitter must not arbitrarily increase the ERP. Legal regulations permit wireless transmitters in the ISM band used in building systems technology to radiate a maximum output of 25 mW ERP.

Attenuation of wireless signals

"Attenuation" is understood generally to mean the weakening of a physical parameter. In the case of radio radiation, "attenuation" is the weakening of the electromagnetic radiation's power – or the ratio between the transmitted and the received radiation power.

Attenuation in free space

In free space, attenuation arises from the fact that the radio radiation from the transmitter antenna is spreading out in the room in a

Attenuation in the free field and in the free space

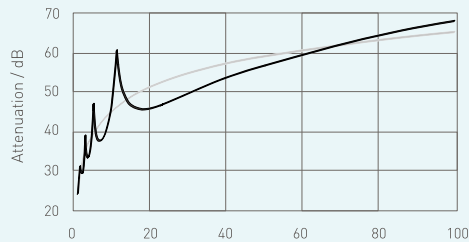

spherical shape. In the far field – at 868 MHz from approx. 2 m – the radiation power arriving at the receiver drops to the square as the distance increases. The attenuation on the transmission path is specified in decibels [dB] in technical documentation.

Attenuation in the free field

The ideal conditions for the “free space” can, however, only be found in outer space. On Earth, there are always limitations that influence the propagation of radio waves – due to reflection, diffraction, refraction and so on. Largely interference-free propagation conditions can be found in the

Free-field measuring station

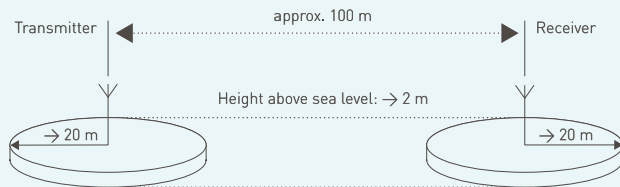

“free field”, in which range measurements are performed too. The free field and the free space differ in that, in the free field, some of the radio waves are reflected on the ground and overlap with the directly radiated wave.

Attenuation due to obstacles

If walls and ceilings are to be penetrated on the transmission path, the attenuation depends to a large extent on the type of construction materials to be penetrated and on the effective wall thicknesses. Some of the incident radio radiation is reflected on the boundary surfaces, while some is absorbed.

Transmission range in the free field depending on the transmitter's installation height

Transmitter's installation height Typical range

> 2.0 m	approx. 100 m
1.5 m	approx. 56 m
1.0 m	approx. 34 m
0.8 m	approx. 28 m
0.6 m	approx. 23 m
0.4 m	approx. 18 m
0.2 m	approx. 13 m

Receiver's installation height: 2 m

Attenuation due to the installation height

Additional attenuation occurs when the transmitter's or receiver's antenna is installed at a lower height. The higher the location of a transmitter or receiver, the better the range. If a wireless device is installed near the ground, its range moves towards zero.

Damp material, such as that found in new builds or newly renovated premises (freshly papered or plastered), attenuates the transmitted radio radiation further. Experiments have shown that attenuation due to moisture can be 4 dB (corresponding to a factor of 2.5) and more.

Attenuation of the wireless signal in buildings

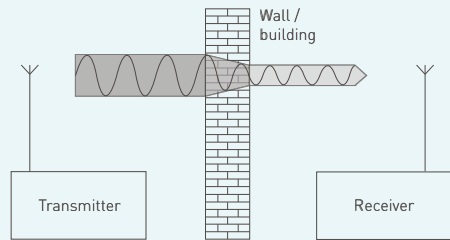

Caution is advised if a building is equipped with shielding materials to reduce "electro smog". Flush-mounted boxes with conductive coatings are hardly suitable for wireless products; special

shielding plasters and gypsum cardboard protective panels into which conductive fibres have been incorporated reduce the penetrability for radio waves by up to 95%. The same applies to stud frames,

Penetration of different construction materials

Material (dry)	Material thickness	Transmission
Wood		
Gypsum, gypsum plasterboards (no metallic stud frame)	< 30 cm	90...100 %
Glass (without any metallisation or wire mesh, no lead glass)		
Brick, press boards	< 30 cm	65...95 %
Reinforced concrete	< 30 cm	10...70 %
Metal grating	< 1 mm	0...10 %
Metal, aluminium lamination	< 1 mm	0 %

Moisture in the material reduces the transmission!

in which high metal contents (e.g. load-bearing parts, metallised insulating material) are installed.

Attenuation due to interference effects

Radio waves reach a receiver both in a direct linear direction and via circuitous routes. Circuitous routes such as these occur due to the reflection of radio waves on boundary

layers with other materials, e.g. on the surfaces of walls.

At the receiver, the radio waves then encounter different overlapping phase positions. In the worst-case scene, the signal can be attenuated or even cancelled out. Even on short transmission paths, the transmission of information can thus be severely impaired.

Attenuation and amplification of wireless signals due to overlapping

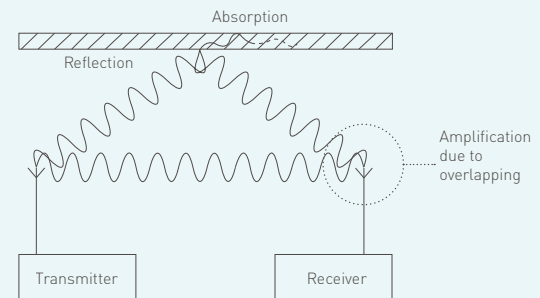
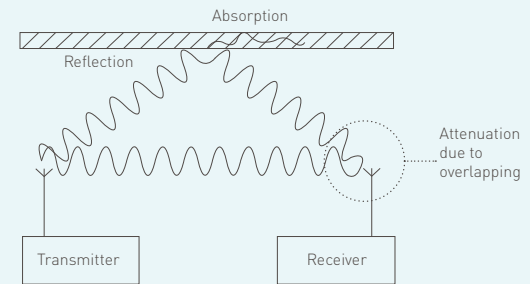

Antenna characteristics and alignment

The reception of wireless signals can be optimised by changing the antenna geometry. Where possible, transmitter and receiver antennae should be installed horizontally and vertically in the same alignment, because the radio wave in the corresponding direction also oscillates ("polarisation").

If both antennae are twisted against one another, the signal available at the receiver is weakened and thus the maximum wireless range is reduced. If transmitter and receiver antennae are perpendicular to one another, the receiver – theoretically – no longer

registers any power radiated directly by the transmitter.

In practical terms, reflections cause the direction of polarisation to rotate, whereby this reflected signal reaches the receiver in an attenuated state.

4. ASSESSMENT OF THE WIRELESS LINK

Due to the large variety of influences, it is difficult to assess wireless links in buildings. Ultimately, a manufacturer of wireless products cannot make a binding statement regarding the wireless transmission range in buildings. And that is why the range in the free field,

which refers to uninterrupted propagation of radio waves and optimally aligned antennae, is always indicated. This is generally 100 m for building systems technology components.

If there are no special structural shielding measures in buildings, wireless transmission through three walls or two ceilings should be possible.

5. ISM AND SRD BANDS

To ensure that radio services do not interrupt one another, the technical use of electromagnetic radiation is regulated by the government. In Germany, this is done by means of publication of a frequency plan in accordance with the Telecommunications Act.

Individual frequency ranges are allocated for the completion of

public authority tasks, such as police radio, the rescue service, broadcasting and so on. Other ranges may be used by private users. Often, the applications are subject to approval and proof of professional qualification is required too – in amateur radio, for example.

No approval process is necessary for radio applications that just have a short range. In addition to CB, radio or mobile services, these include applications for industrial, scientific and medical purposes. The "ISM frequency ranges" (industrial, scientific, medical) are reserved for these applications, and may also be used for short-range devices (SRDs), i.e. low-power radio applications such as headphones, radio remote controls or data transmission, to name but a few examples.

eNet's typical range in buildings:
Penetration of two ceilings and three walls

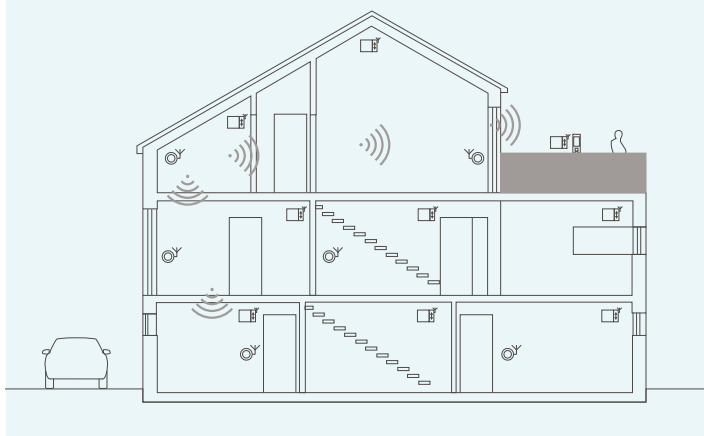

Overview of some ISM and SRD bands

Frequency f	Wavelength λ	Transmission power
433.05 – 434.79 MHz	6.93 – 6.90 dm	Max. 10 mW (for SRDs)
868.0 – 868.6 MHz	3.46 – 3.45 dm	Max. 25 mW
2.40 – 2.48 GHz	12.5 – 12 cm	Max. 10 mW

eNet uses the 868.0 to 868.6 MHz frequency band, which still has good propagation properties in buildings, because attenuation due to walls, concrete reinforcement and metal content is kept within certain limits. Furthermore, it is exclusively intended for SRD purposes throughout the whole of Europe.

Maximum permissible transmission period

To ensure that radio systems interrupt one another as little as possible, radio approval limits the permissible transmission period using "duty cycles". The official general allocation defines this term as follows:

- "The working cycle (relative frequency occupancy period or duty cycle in %) is defined as the proportional active transmission operation within a one-hour period at any given time."

Federal Network Agency: Regulation 30/2014, modified by Regulation 36/2014, modified by Regulation 69/2014, last updated: 18 December 2014

SRDs in the 868.0 to 868.6 MHz frequency band may transmit a maximum of 1%, i.e. for a total of 36 seconds, within one hour.

To ensure that an eNet transmitter does not remain unusable for the rest of the hour once the limit – which is unreasonable in a do-

mestic installation – is reached, the transmitters limit their transmission behaviour to the basic function that is necessary for the user once a certain percentage of the limit has been reached, by postponing status queries and only sending the most important operating commands.

The eNet transmitters' transmission management divides the evaluation process up over short periods, so that there is a sufficient reserve remaining in any case.

6. BIOLOGICAL EFFECT ON HUMANS

eNet uses extremely low radiation powers of max. 20 mW, and thus remains below the permitted limits. With regard to assessing the extent to which these values may influence biological systems such as humans, it is useful to compare with other radio services we use in our everyday lives:

- Mobile phones (UMTS or DECT) give off radiation of up to 2,000 mW. During operation, they do so in the direct vicinity of our heads. The same applies to wireless hands-free equipment, whose reduced radiation power still reaches 100 mW. When on the move in a car, the metallic body causes the radio radiation to be concentrated on the car interior and thus on the car users.

- While microwave ovens do indeed shield their interiors with metallic materials, with their peak powers of 1,500 W small proportions of radio radiation measuring a mere 2.45 GHz (frequency similar to WLAN) do still escape, particularly from the door.

- Wireless computer networks (WLAN) are now an integral part of our home lives. Here, transmission values can reach 2.4 GHz with a power of up to 100 mW, and 5 GHz with a power of up to 200 mW.

- Transmission systems for radios and TVs have transmission values of up to 100 kW and 10 kW for analogue and digital systems respectively. In this regard, digital broadcasting does not transmit continuously, but rather in pulse-like signals.

- Even in nature, we humans are surrounded by natural radiation of all frequencies. While the Earth's magnetic field does indeed provide protection from most of the radiation from outer space, it cannot eliminate all the influences entirely.

eNet devices do not transmit continuously, and neither are they operated in the immediate vicinity of the body. When compared to a mobile phone, only a fraction of the radiation power reaches the

human body – and at a distance of one metre, for example, this fraction is a mere ten thousandth. This examination quickly clarifies that the radio load of eNet installations remains extremely low, and that there is no need to worry about damaging health effects.

7. TECHNICAL DATA FOR eNeT AND eNeT SMART HOME

Radio frequency	868.0–868.6 MHz
Transmission power	Max. 20 mW
Transmission rate	16,384 bit/s
Modulation	FSK, Manchester
Communication type	Bidirectional
Topology	Free
Organisation	Decentralised
Max. permissible transmission period	1%/h
Wireless encryption	AES-128/CCM
Transmission range:	
· In the free field	Typically 100 m
· In the building	Typically 30 m
System range (with two repeaters):	
· In the free field	Typically 300 m
· In the building	Typically 100 m
Power supply	Battery or mains
Battery life	Up to 10 years (depending on the operating frequency)

All of the information given below is per system

Number of wireless devices	Typically 100
Operating channels:	
· Single channels	Typically 400
· Scenes	Typically 100
SMART HOME scenes	Up to 34
Timing functions	Up to 100
If-then rules	Up to 32
Administrators	1 user account
App users:	
· With rights to make settings	10 user accounts
· Operation only	10 user accounts
Actions in scenes	Up to 100
Actions in rules	Up to 32
Subsequent actions in rules	Up to 32
Conditions in rules	Up to 32
Actions in schedules	Up to 100
Smartphones and tablets with app	8 at the same time (local and remote access)

UPDATING TO eNet SMART HOME

1. UPDATING eNet SYSTEMS WITH SERVERS FROM V1.X TO V2.0

The V2.0 update turns an eNet system into an eNet SMART HOME system. V2.0 includes numerous improvements with respect to operation, speed and security. The behaviour and the functionality of the eNet system may, however, change substantially due to the update and the subsequent project conversion. Certain functions are no longer available in V2.0: You'll find details such as checklists, update files, etc. at update.enet-smarthome.com.

2. TO INCLUDE eNet SMART HOME

eNet systems (without a server) can be integrated into the eNet SMART HOME world at any time by adding a V2.x eNet server.

When reading in the existing devices, the available connections between the devices and their configurations are adopted. The existing, manually programmed scenes are not adopted.

Proceed as follows to expand a system to include eNet SMART HOME:

- Install the eNet server and connect it to your PC.
- Start the eNet SMART HOME connect commissioning interface in the web browser, and create a new project and room structure.
- Start a device search to search for eNet devices.
- Put eNet devices into Programming mode until all eNet devices have been recorded by the server.
- Assign recorded eNet devices to their relevant installation locations.
- Update the eNet devices' software if necessary.

The system is now updated, and all the eNet SMART HOME functions are available.

COMPATIBILITY WITH IN-WALL SYSTEMS

The following in-wall systems from the manufacturers Gira and JUNG are supported:

- Gira System 3000
- JUNG LB management

With the help of operating top units:

- Gira eNet operating top unit (Memory)
- JUNG eNet centre plate (Standard).

The eNet system now integrates conventional flush-mounted systems:

- Gira System 2000
- Gira Blind System
- JUNG Light Management
- JUNG Blind Management

using eNet operating top units:





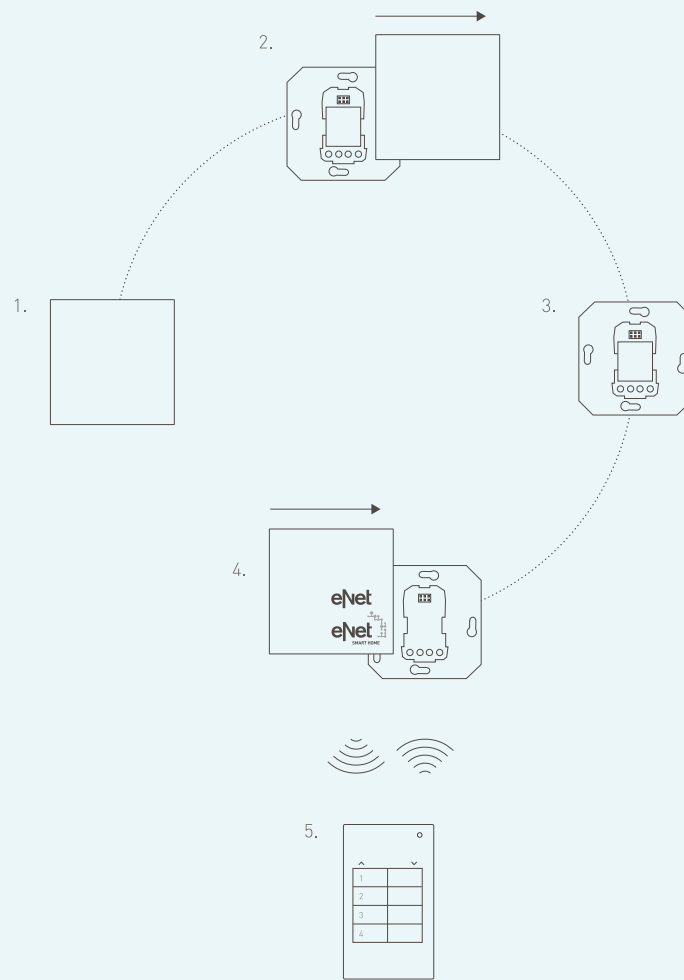

- eNet blind button
- eNet button for the switching/dimming insert

The established auxiliary unit technologies for the flush-mounted systems remain unchanged in this regard and can still be put to flexible use.

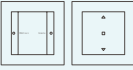
Existing touch dimmers and blind inserts can be easily integrated into the eNet system and thus extended to include new functions by means of simply replacing the existing operating top units. All eNet operating top units support both eNet and eNet SMART HOME, and enable all the corresponding functions.

Replacement of operating top units with eNet operating top units

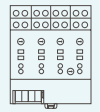

Transmitters		Actuators		Sensors			Others	FUNCTIONS	DESIGN
TRANSMITTERS	SWITCHING/ PRESSING	DIMMING	BLIND	ENERGY	MOTION	SUN	SYSTEM DEVICES		
<ul style="list-style-type: none"> • Wireless wall transmitter, 1-gang System 55* • Wireless wall transmitter, 3-gang System 55* • eNet wireless operating top unit Memory*** • eNet wireless operating top unit*** 	<ul style="list-style-type: none"> • Wireless switching and dimming top unit, 1-gang* • eNet wireless operating top unit Memory*** • eNet wireless operating top unit*** 	<ul style="list-style-type: none"> • Wireless switching and dimming top unit, 1-gang* • eNet wireless operating top unit Memory*** • eNet wireless operating top unit*** 	<ul style="list-style-type: none"> • Wireless blind control button, 1-gang* • eNet wireless operating top unit Memory*** • eNet wireless operating top unit*** 				<ul style="list-style-type: none"> • Gira G1 	eNet WALL TRANSMITTERS AND OPERATING TOP UNITS 	
<ul style="list-style-type: none"> • eNet wireless wall transmitter module, 1-gang • eNet wireless wall transmitter module, 2-gang • eNet wireless wall transmitter module, 3-gang • eNet wireless wall transmitter module, 4-gang • eNet radio centre plate Standard*** 	<ul style="list-style-type: none"> • eNet radio centre plate (for light management)* • eNet radio centre plate*** • eNet radio centre plate Standard*** 	<ul style="list-style-type: none"> • eNet radio centre plate (for light management)* • eNet radio centre plate*** • eNet radio centre plate Standard*** 	<ul style="list-style-type: none"> • eNet radio centre plate for blinds control* • eNet radio centre plate*** • eNet radio centre plate Standard*** 				<ul style="list-style-type: none"> • JUNG SC5 /SC7 	JUNG 	
<ul style="list-style-type: none"> • Hand-held transmitter, 1-gang • Hand-held transmitter, 2-gang • Hand-held transmitter, 4-gang • Hand-held transmitter display** 							<ul style="list-style-type: none"> • Diagnostic device** 	eNet HAND-HELD TRANSMITTERS 	
<ul style="list-style-type: none"> • Universal transmitter, 2-gang Mini 	<ul style="list-style-type: none"> • Switching actuator, 1-gang Mini • Switching actuator, 2-gang Mini 	<ul style="list-style-type: none"> • Dimming actuator, 1-gang Mini • Control unit 1 – 10 V 1-gang Mini • DALI control unit, 1-gang Mini 	<ul style="list-style-type: none"> • Blinds actuator, 1-gang Mini 	<ul style="list-style-type: none"> • Energy sensor, 1-gang Mini 				eNet DEVICES IN THE MINI HOUSING 	
	<ul style="list-style-type: none"> • Switching actuator, 1-gang DRA • Switching/blinds actuator, 8/4-gang DRA 	<ul style="list-style-type: none"> • Dimming actuator, 1-gang DRA • Dimming actuator, 4-gang DRA 	<ul style="list-style-type: none"> • Blinds actuator, 1-gang DRA • Switching/blinds actuator, 8/4-gang DRA 	<ul style="list-style-type: none"> • Energy sensor, 4-gang DRA 			<ul style="list-style-type: none"> • eNet server • DRA receiver module 	eNet RAIL-MOUNTED DEVICES (DRAs) 	
	<ul style="list-style-type: none"> • Switching actuator intermediate adapter**** 			<ul style="list-style-type: none"> • Adapter plug for energy sensor**** 			<ul style="list-style-type: none"> • Adapter plug for repeater**** 	eNet ADAPTER PLUGS**** 	
					<ul style="list-style-type: none"> • Steinel SensIQ • Steinel XLED Pro • JUNG eNet motion detector 	<ul style="list-style-type: none"> • Sun/twilight sensor Solar 	<ul style="list-style-type: none"> • tado° Professional heating system control 	OTHERS 	

* In conjunction with switching, dimming or blind inserts

** Not compatible with eNet SMART HOME – cannot be used with the eNet server

*** Only in conjunction with the corresponding LB management insert

**** No longer available for reorder.

Brumberg

Leuchten GmbH & Co. KG

Hellefelder Str. 63

D-59846 Sundern

Phone +49 29 34 96 11 0

Fax +49 29 34 96 11 96

www.brumberg.com

info@brumberg.com

Gira

Giersiepen GmbH & Co. KG

Dahlienstraße

D-42477 Radevormwald

P.O. Box 12 20

D-42461 Radevormwald

Phone +49 21 95 602 0

Fax +49 21 95 602 191

www.gira.com

info@gira.com

Häfele GmbH & Co KG

Adolf-Häfele-Str. 1

D-72202 Nagold

Phone +49 74 52 95 0

Fax +49 74 52 95 200

www.haefele.co.uk

info@haefele.co.uk

JUNG

Albrecht JUNG GmbH & Co. KG

Volmestraße 1

D-58579 Schalksmühle

P.O. Box 13 20

D-58569 Schalksmühle

Phone +49 23 55 806 0

Fax +49 23 55 806 189

www.jung.de/en

kundencenter@jung.de

www.enet-smarthome.com

Siedle

S. Siedle & Söhne,

Telefon und Telegrafengeräte OHG

Bregstraße 1

D-78120 Furtwangen

P.O. Box 11 55

D-78113 Furtwangen

Phone +49 77 23 63 375

Fax +49 77 23 63 313

www.siedle.com

info@siedle.com

STEINEL Vertrieb GmbH

Dieselstraße 80 - 84

D-33442 Herzebrock-Clarholz

Phone +49 52 45 448 149

Fax +49 52 45 448 173

www.steinel-professional.de

info@steinel.de

tado° GmbH

Sapporobogen 6-8

D-80637 München

Phone +49 89 71 67 78 624

www.tado.com/gb

contact@tado.com

eNet SMART HOME

Service Secretariat

Hohenzollernstraße 5

D-30161 Hannover

Phone +49 511 16 767 378

Fax +49 511 16 767 379

www.enet-smarthome.com

info@enet-smarthome.com